

D. Zh. Abdeli¹,
orcid.org/0000-0002-1753-4952,
Wisup Bae²,
orcid.org/0000-0002-2908-2914,
A. B. Seiden¹,
orcid.org/0000-0002-4988-8368,
Adi Novriansyah³,
orcid.org/0000-0001-6033-326X

1 – Satbayev University, Almaty, the Republic of Kazakhstan,
e-mail: assel_seiden@mail.ru
2 – Department of Mineral and Resources Engineering, Se-
jong University, Seoul, the Republic of Korea
3 – Department Petroleum Engineering, Universitas Islam
Riau, Pekanbaru, the Republic of Indonesia

TREATMENT OF FORMATION WATER AT OIL FIELDS USING GRANULAR FILTERS WITH VARYING PARTICLE SIZES

Purpose. Increasing oil recovery from reservoirs, reducing water content, and decreasing costs by pumping formation water effectively cleaned of suspended solids allows you to get a picture of the uniform distribution of water over the reservoir and, in general, the quality maintenance of reservoir pressure in productive reservoirs.

Methodology. The study on water treatment issues for maintaining reservoir pressure at existing oil fields has a variety of approaches. Therefore, the methods of analysis, review, comparison, modeling, experiment were used in the work. The analysis method made it possible to divide the problems of approaches to the formation water preparation for its injection into the reservoir into many elements, which made it possible to learn their properties, connections and relationships. This method contributes to a more detailed structuring of the problem of water treatment. The analogy method uses the study of the technology of preparation of reservoir water with suspended solids. Based on the data, an effective technology was studied for treating formation water from suspended solids and injecting it into a productive formation.

Findings. The experiments carried out reflect the high-quality water preparation using the developed new industrial sand-gravel filter made of granular materials with variable particle sizes in the vertical direction, taking into account the rational parameters of the column height of the filter working area. The regularities were studied and the process of formation water preparation without suspended solid particles was improved on the basis of the theoretical and experimental studies carried out on a special laboratory unit. The dependence of the reservoir permeability in the bottomhole zone of injection wells on the size of solid suspended particles in the injected water was determined, and rational filter parameters were established for preparing injected water without suspended solid particles into the reservoir using granular materials with a variable fraction and water supply from the bottom up.

Originality. An effective technology for deep purification of formation water from suspended clay particles is proposed by using filters made of granular materials with a variable particle size. The technical result of the invention is to increase the efficiency of purification of industrial waste and industrial formation waters with suspended solids.

Practical value. A new method for deep formation water treatment is proposed, which ensures the capture of suspended solids. The results of experiments on establishing the regularity of the process of formation water filtration with suspended clay particles through a porous medium with variable pore sizes and granular particles are presented. A recommendation has been developed for choosing rational parameters and operating modes of a new filter for formation water treatment.

Keywords: *oil reservoirs, water, treatment, filter, granular material, well*

Introduction. Oil production at fields at their intermediate and late stages of exploitation is characterized by the need to inject water into the reservoir to maintain pressure. Adding water is generally accepted as not only a way to increase the speed, but also to help achieve the maximum recovery of hydrocarbons. At many fields, water is pumped into formations where particles have already accumulated, because the water has not been allowed proper time to settle in tanks, thus the pores of the rock in the bottomhole zone have reduced permeability. As a result, the flow rates at injection wells and, therefore, those of production wells decrease to unacceptable levels. Due to declining profitability from low productivity, membrane filters for thorough water filtration, coalescing filters, and hydrocyclones are not used to remove suspended particles from formation water at such fields.

The three requirements for use of oil field wastewater in water flooding are: the content of emulsified oil and particulate solids, the microbiological makeup, and the chemical compatibility of the water and reservoir rocks. In Kazakhstan, and indeed most countries, in order to avoid complications during water injection into the reservoir, the water must meet certain quality standards. According to ST 1662-2007 of the Republic of Kazakhstan (Tables 1 and 2), the mass of mechanical impurities per liter of water, depending on the permeability and fracturing of the reservoir rock, should be from 3 to 50 mg. At the same time, requirements are also imposed on the quality of injection water in accordance with the following measurements: stability, swellability, content of mechanical impurities, size of suspended particles, content of

oil products, oxygen content, iron content, hydrogen sulfide content, content of SRB (sulfate-reducing bacteria), corrosion rate, and compatibility with produced water [1].

A distinctive feature of operating a field in the middle and late stages of exploitation is the annual increase in the water cut, which usually exceeds 80–90 %, thus in turn significantly complicating the operation of those facilities used in processing oil, gas and water. Treatment of large volumes of associated formation water requires significant material, energy and labor costs.

For example, at the Uzen field in Kazakhstan, the total volume of produced water exceeds 45 million cubic meters per year. Water that is reinjected from the free water knockout units (FWKO-1 and FWKO-2) and the central processing facility (CPF) constitutes about 70 % of the volume of injection water, whereas seawater from the Caspian Sea makes up around 30 % of the remainder, as supplied to the field through a system of four pumps. The design capacity of each FWKO is 16.4 million m³/year (45 thousand m³/day), although the actual workload of both FWKO-1 and -2 is 1.3 times higher than the stated capacity [2].

A diagram of the existing water treatment technology is shown in Fig. 1. As seen in the diagram, horizontal sedimentation tanks and electric dehydrators are used to separate the oil-water emulsion. Oil desalination is carried out by using a dehydration sump to separate salt water and supply fresh water to the mixer before the electric dehydrator.

Due to the increased load on the water supplied to both FWKO-1 and -2, not enough settling time is allowed in the system, which leads to deterioration in the quality of the water used

Table 1

The physicochemical parameters of wastewater as required by ST RK -1662-2007

Permeability of porous reservoir medium, micron ²	Reservoir fracture coefficient	Permissible content in water, mg/l	
		mechanical impurities	oil
up to 0.1, incl.	—	up to 3	up to 5
over 0.1	—	up to 5	up to 10
up to 0.35, incl.	from 6.5 to 2, incl.	up to 15	up to 15
over 0.35	less than 2	up to 30	up to 30
up to 0.6, incl.	from 3.5 to 3.6, incl.	up to 40	up to 40
over 0.6	less than 3.6	up to 50	up to 50

Table 2

Requirements for the quality of injection water

No.	Parameters	Requirements
1	Stability	Consistent over time
2	Swelling	N/A
3	Mechanical impurities content	The heterogeneity of reservoir properties must be taken into account
4	Suspended particle size	90 % less than 5 microns
5	Content of oil products	Based on the reservoir properties, no more than 10–30 mg/l L
6	Oxygen content	Less than 0.5 mg/l L
7	Iron content	Less than 1 mg/l L
8	Hydrogen sulfide content	N/A
9	Content of SRB	N/A
10	Corrosion rate	Less than 0.1 mm/year
11	Formation water compatibility	Must be compatible, with reduction of injectivity at no more than 20 %

in formation pressure maintenance (FPM), as well as being inconsistent with Kazakhstani regulatory requirements for the quality of the water supplied for injection into reservoirs. Laboratory research shows that the optimal time for the first stage of settling of the water-oil emulsion discharge at both FWKO-1 and -2 is 50–60 minutes. As well, the optimal time for the second stage of wastewater sedimentation, which includes cleaning of mechanical impurities and oil products, is 4 hours, a period that is not followed. The studies that were carried out show the active processes of development of biocenoses of sulfate-reducing bacteria, which are in seawater, take place in the production

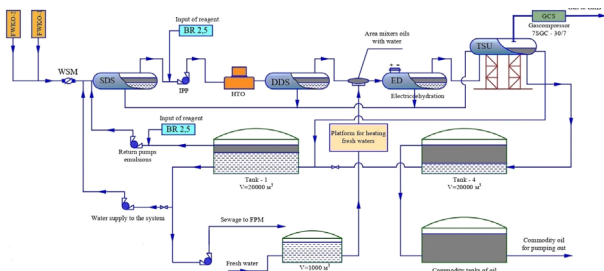

Fig. 1. Flow diagram of the produced water treatment unit (PWTU) for water injection at the Uzen field

layers of fields. This leads to intensification of corrosion processes and rapid wear of oilfield equipment and pipelines.

These factors negatively affect the turnaround period of production wells, due to premature failures of downhole pumping equipment, which becomes clogged by various mechanical impurities and corrodes because of increased salinity, among other factors (Table 3). Particulate matter in the injection water directly affects the pressure and the degree of degradation in the tight sandstone formation of the Uzen field [3]. Based on the data presented, mechanical impurities taken from pump components are mainly sand (14–90 %) and crystalline salt (10–86 %), depending on pump placement within the system. The negative effect of mechanical impurities on the operation of plunger rod pumps (PRPUs) is manifested in the wear on the plungers, intake and discharge valves, among other parts (Fig. 2) [4].

The need to protect underground equipment from mechanical impurities is because their presence leads to premature wear of the production string and pumping equipment, which ultimately results in additional repairs. Control over the composition of injection water, including analysis of oil products and mechanical impurities, is carried out daily. The results of quality control of injection water at this field, as obtained by specialists from RN-UfaNIPIneft, KazNIPIneft, and ITC RK (Engineering and technical center), are shown in Table 3.

According to the data obtained, the content of mechanical impurities in the injection water at the inlet of the water injection station (WIS) exceeds the standard indicators. Consequently, the process of water treatment requires improvement in terms of removing such impurities. As follows from the data presented (Fig. 3), the main causes of well production maintenance (WPM) include: pump change due to mechanical impurities and scaling – 29 %, tubing leakage – 22 %, jamming of pump – 13 %, and breakage of rods – 9 %. Asphalt, resin and paraffin deposits, mineral scale deposits, and mechanical impurities result in failures such as pump jamming and rod breakage. The high percentage of WPM due to mechanical impurities and mineral scale deposits is extremely difficult to eliminate, and requires an integrated approach using mechanical and chemical means of avoidance. As follows from the data presented (Table 4), in the samples of production water, the content of solids significantly exceeds standards, as it ranges



Fig. 2. Wear of a valve pair due to the ingress of mechanical impurities into the pump

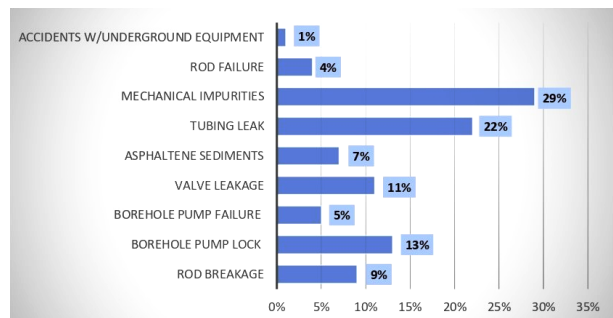

Fig. 3. Reasons for well production maintenance (WPM) over a period of six months, requiring repairs to plunger rod pumps (PRPUs)

Table 3

Results of control of mechanical impurities and oil products (average monthly indicators) in the injection water at the Uzen field

Indicator		Company Name		
		RN-UfaNIPIneft	KazNIPIneft	ITC
pH		≥7	5.7–6.8	6–6.5
Density, g/l		1.036–1.048	1.027–1.055	1.035–1.090
Total mineralization, g/l		42,54–45,03	26–75	32.68–103.28
Type of ground water, according to the Sulin classification system		CC*	CC*	CC*
Hydrogen sulfide, mg/l		17	2–510	7.4–37
Sulfate-reducing bacteria, cells/ml		10–10 ²	10–10 ⁵	no data
The content of oil at the outlet (mg/l):	CPF	8–780	87–530	21–270
	FWKO-1	19.8–87	51–702	32–150
	FWKO-2	38.4–71.8	110–803	32–180
The content of m/i* at the outlet (mg/l):	CPF	160–760	2.5–470	22–52
	FWKO-1	310–350	54–237	27–42
	FWKO-2	320–360	50–163	26–59
The content of m/i* at the inlet of the water injection station (WIS), mg/l		300–1030	40–176	no data

CC* – calcium chloride; m/i* – mechanical impurities

Table 4

Physicochemical properties of reservoir and ground samples of associated water from the Uzen field

The content of m/i, mg/dm ³ (salt-sand, %)	Depth, m	Date	Indicators	
2100 (75–25 %)	1121.4	02.10	4733	Wells
3800 (70–30 %)	1160.5	27.09	4733	
600 (65–35 %)	1359.4	01.10	9127	
1500 (70–30 %)	1218.4	02.10	9127	
4615.6 (75–25 %)	1330	06.10	9128	
718 (70–30 %)	GS - 88	01.10	1	OGPD – Oil and Gas Production Division
5320 (75–25 %)	GS - 89	01.10	1	
1068.8 (65–35 %)	GS - 4	02.10	1	
497 (75–25 %)	GS - 85	02.10	1	
5030 (70–30 %)	GS - 87	01.10	1	
257.6 (65–35 %)	GS - 77	27.09	3	

m/i* – mechanical impurities; GS – gathering station

from 600 to 4615.6 mg/dm³ (0.06 to 0.46 % of the total mass), and primarily includes salt (65–75 %) and sand (25–35 %).

Of note is that currently, at many fields, the basic methods of treatment of oilfield wastewater across the industry are mechanical and physicochemical. The most common is the settling method, as it is the simplest and cheapest, which in many cases meets the necessary requirements for water quality. Most fields use only this method, whereas some use a combination of filtration and physicochemical methods. The settling method, although simple, has some drawbacks, including: the characteristics of contaminants (dispersity, stability, and so on) may limit their precipitation from the solution, and the sometimes lengthy period that is necessary. Therefore, in recent years, to increase the productivity of equipment and the quality of injection water, tools have been developed, such as sedimentation tanks for thin-layer sedimentation, with membrane filters for thorough water filtration, coalescing filters, and hydrocyclones, among others.

The main equipment used to clean mechanical impurities from water in the Uzen field is sedimentation tanks. However, as a result of the constant flow of the water through the tanks, a large number of mechanical impurities, ranging from light to

average weight, fail to be deposited, and are thus carried along by the injection water into the bottomhole zone of the reservoir. After some time, there is a significant decrease in the effectiveness of injection wells, and a resulting increase in power consumption by the pumping station.

Literature review. Most studies show that water quality is a very important parameter for proper functioning of reservoirs. The authors of the article [6] propose to use modular water purification systems for water treatment, which include up to three stages of purification, depending on the operating conditions. The first stage is a separator of mechanical impurities. The second stage is the filtering part with filter elements made of wire permeable material (WPM) without hydrophilic and oleophobic coatings. The third stage is a sorber, which provides complete purification of water from residual oil. This system can be installed in FWKO systems or directly at the wellhead of an injection well. Pilot tests of the presented treatment system were successfully completed at the facilities of LLC “LUKOIL-Perm” – the Unvinskoye field (water from surface sources) and the FWKO Byrka OGPD-3 (bottom water). The results of the test showed a 2.9-fold decrease in the

content of SPM with an average particle size of 2.5 μm and a 2.1-fold decrease in the amount of residual oil. However, the use of the proposed apparatus in the field environment has some disadvantages. First of all, it is their high cost, significant power consumption and, most importantly, this is the placement of the system only near transport routes.

It is well known that under the action of intense sound waves, coagulation and precipitation of smoke particles suspended in the air occur. These observations allowed the authors Mukhamadeev and Voltsov [7] to suggest that one of the promising methods for accelerating the process of removing contaminants smaller than 20 μm can be vibro-acoustic treatment of the flow. Studies on magnetic-vibration intensification of the process of separation of water-oil emulsions and purification of formation water showed that the most effective frequencies for influencing the flow are the range of 50–120 Hz. The disadvantage of the conducted research is the lack of focus on studying the mechanism of the processes occurring in this case, it is impossible to create scientifically based calculation methods, which predetermined their relatively low efficiency. In practice, it is often not possible to reduce the content of mechanical impurities in water to the maximum permissible concentrations (MPC).

The performed studies [8] show that the required quality of oil dehydration and wastewater treatment can be achieved by sequential treatment of the oil-water mixture with chemical reagents: demulsifiers and flocculants. The effectiveness of the action of flocculants depends on the component composition of impurities present in the water phase of oil-water mixtures supplied to the FWKO. The disadvantage of the method is the dependence of the coefficients on the individual properties of formation waters.

With the participation of employees of Samaraneftgaz JSC [9] a unique separator design has been developed. It includes an upgraded inlet unit, a process unit with coalescers, a vertical baffle and upgraded liquid outlet pipes. The developed design ensures stable operation of the separator due to the uniform distribution of the emulsion entering it, the creation of an additional area of contact between the emulsion and the surface of the coalescing element, the alignment of the flow, followed by gravitational settling of the gas-liquid mixture prepared for separation and the removal of separated oil and water.

Pilot tests show that the volume of water pumped to the reservoir pressure maintenance system increases, and the volume of ballast pumping of fluid to the next collection point decreases. As a result of reducing the volume of pumped liquid and optimizing the operation of pumping equipment, monthly electricity consumption decreased by 23 thousand kWh. The disadvantage of the device is the non-uniform loading of filter cartridges along their length with separated impurities, especially at large ratios of the length of the cartridge to its diameter and when separating particles with a high density, while the free section of the coalescing cartridge decreases, its productivity decreases and its hydraulic resistance increases.

In his article, Golubev [10] outlined the existing problem of poor-quality wastewater pumped into the FPM system. Notably, a constant increase in the water cut has led to existing water treatment plants being unable to cope with such large volumes, while additionally not bringing the water to the required quality. In order to solve these problems, Golubev proposes using a cluster of powerful pumps, which make it possible to reuse the bulk of water produced directly at the field, having previously ensured that it meets appropriate standards. Despite proposals for several hardware options, inefficiency exists when utilizing clusters of powerful pumps due to poor control of the quality and quantity of water supplied to the injection well.

Of note are the studies carried out at Kazan State University of Architecture and Civil Engineering (KSUAE) on the implementation of hydrocyclone installations in treatment of water used for flooding [11], as they have a high specific productivity, compactness, are fully automated, and are available in complete-

ly pre-made blocks. These features enable an effective technology for the treatment of wastewater at the lowest material and energy costs. The disadvantage of this technology is the low degree of separation and the complexity of removing floating substances. So as to reduce the concentration of oil products and mechanical impurities in wastewater up to 10 mg/l, fast or ultra-fast filters should be added to the system after the hydrocyclone unit.

Ramesh Chandra Yerramilli, et al. [12] present experimental and simulated results relating to blockage caused at various concentrations of particles and the effect on the intensity of water injection. Of importance is the fact that an increase in resistance and a decrease in injection rate were observed with an increase in the concentration of particles, whose number per unit of volume in the solution increases, resulting in a decrease in permeability. As the concentration of the injected particles rises, the intensity of damage also increases. In addition, with an increase in the concentration of particles, the transition time shifts to lower values, because at higher concentrations, the rate of build-up in the internal filter cake (IFC) and external filter cake (EFC) increases, which can be seen from the transition time obtained from the impedance profiles at various particle concentrations.

Azim Kalantariasl, et al. [13] noted that a higher concentration of particles leads to more damage and settling, thus also contributing to the clogging of pores in reservoirs. Large particles have a higher tendency to settle and cause severe damage to a formation. With any water treatment system, a certain quantity of suspended solids always remains in the water, which gradually contaminates the filtering surface of the bottomhole zone. The intensity of filtration attenuation depends on the nature of the suspension and the size of the pore channels of the flooded reservoir [14–16]. Due to heavy contamination of the filtration surface, the permeability of the reservoir in the bottomhole zone is reduced tenfold, thus industrial water injection becomes impossible. Therefore, progressive contamination of the filter surfaces of injection wells should not be allowed [17, 18].

Despite the importance of the issue, as well as a fairly large number of publications devoted to the research of thorough filtration of suspended solid particles from reservoir water and its uniform injection into oil reservoirs, the above problem remains relevant.

Methods of formation water treatment. In order to assess the effectiveness of a new technology for the thorough removal of suspended particles from formation water, the research team drew up equations for the flow rates of radial filtration of formation water according to Darcy's law. The flow rate of production wells does not decrease if the initial flow rate of the radial filtration of oil-displacing water (Q_1) does not change during the entire operating life of the wells.

However, due to the presence of a large quantity of suspended solid particles in the composition of injection water, resulting in clogging of the pores in the rock, the permeability of oil reservoirs is significantly reduced. In this case, the initial flow rate of the radial filtration of oil-displacing water decreases in value according to Darcy's law. The parameters can be defined as

$$Q_1 = \frac{A k_1 dp}{\mu_1 dR} \geq Q_2 = \frac{A k_2 dp}{\mu_2 dR},$$

where A is the filtration area of the bottom-hole formation zone; k_1 and k_2 are the reservoir permeability during injection of reservoir water, without and with suspended particles, respectively; dp is the pressure change from bottom-hole p_0 to reservoir pressure p ; μ_1 and μ_2 are the viscosities of the injection water, without and with suspended particles, respectively; dR is the change in the contour of the drainage area from 0 to R .

After integrating the variable parameters, the following is obtained

$$Q_1 \int_0^R dL = \frac{A k_1 dp}{\mu_1} \int_{p_0}^p dp \geq Q_2 \int_0^R dL = \frac{A k_2 dp}{\mu_2} \int_{p_0}^p dp;$$

$$Q_1 = \frac{Ak_1(p-p_0)}{\mu_1 R} \geq Q_2 = \frac{Ak_2(p-p_0)}{\mu_2 R}. \quad (1)$$

After reduction, the following is obtained

$$\frac{k_1}{\mu_1} \geq \frac{k_2}{\mu_2} \quad \text{or} \quad k_1 \geq \frac{k_2}{\mu_2} \mu_1.$$

The results show that a decrease in injection well flow rate results in reduction of the permeability of the bottomhole zone because of increased viscosity of the injection water due to suspended particles. Clearly, this increases the resistance to the movement of water, resulting in reduced oil displacement and an increase in the power consumption of pumping stations. The effectiveness of production wells is significantly reduced, as the volume of water injected into oil reservoirs increases over time. This suggests that the creation of a new technology for the filtration of formation water is necessary, thus providing thorough removal of suspended particles.

The research team has received a patent for a method of thorough filtration of suspended solids from reservoir and waste water [19]. This method involves supplying reservoir water (Fig. 4, *a*) through an inlet 1 to the lower compartment 2 of the device, thus forcing fluid from the bottom to the top, sequentially. Fluid flows upwards through a perforated partition 3 and a layered filter made of granular material with each layer having particular size of the particles. Each layer is separated by a perforated plate so as to prevent mixing. The bottom 4 and the top 5 layers have the maximum overall dimensions of particle size, whereas the minimum overall particle dimensions are in middle layer 6. As a result, suspended solids do not clog the pores of the filter, but instead sink and accumulate in the lower wedge-shaped portion of the unit. The filtered reservoir water *II* is discharged through the outlet nozzle 7. The lower outlet pipe 8, allows the accumulated particles *III* to be periodically removed. If the filtered water is contaminated with sulfide-reducing bacteria, it can be treated with oxidizing gas *IV*, such as ozone, which is supplied through perforated tubes 9 that evenly distribute the injected gas in the upper section of the unit. Exhaust gas *V* can escape via the outlet pipe 10. After filtration, the water, now free of suspended solid particles, is directed to maintain reservoir pressure.

The layout of a system that utilizes this technology is shown in Fig. 4, *b*, which consists of two reservoirs, a settling tank 1 and filtered water tank 2. Between the two tanks there are granular filters 3, 4, as well as pumping units 5, 6. The filtered water is directed to injection wells *VII*.

As particles accumulate in the lower part of the granular filter, the supply of water is stopped for a set time. Through the lower branch of outlet 8, accumulated particles *III* are removed along with any coagulated materials and reagents. In Fig. 4, *b*, in order to clean the reservoir water as thoroughly as possible, a second granular filter is shown connected to the system.

Results. When establishing acceptable parameters in designing this new technology for water treatment, an experimental study of the filtration process of formation water through a

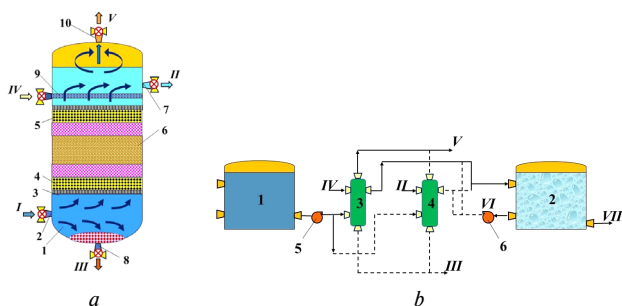

Fig. 4. Schemes of the granular filter (a) and the full system (b) for the preparation of reservoir water

granular filter with varying particle sizes was carried out. The experimental setup (Figs. 5, *a* and 5, *b*) consists of a vertical cylindrical container 1 (Fig. 5) made of plexiglass, with an inlet 2 and outlet 3 nozzles. The length of the cylindrical structure is 670 mm, and its diameter is 90 mm. Inside the cylinder are: the lower compartment 4, two perforated metal disks 5, located above and below the filter unit 6, which consists of several layers of granular materials, each separated by a perforated plate so as to prevent mixing, and the upper compartment 8. The upper and lower perforated disks are connected in the middle with a bolt in order to maintain the rigidity of the filter portion.

The water to be filtered is supplied from a reservoir 9, located above the filter apparatus so as to utilize gravity feed, through a control valve 10 and a tube 11, leading into the lower compartment of the apparatus. The filtered water flows through a pipe 12 into a tank 13. The whole apparatus and the water tanks are mounted on a frame 14.

The granular filter consists of five layers with varying particle sizes. The first and fifth layers are 25 mm in height and are composed of ceramic balls with sizes ranging from 3 to 5 mm. The second and fourth layers are also 25 mm in height and made up of small stones and coarse sand with particle sizes from 1 to 2 mm. Finally, the third, or middle, layer has a height of *h*, which was varied between experiments, and is made up of sand with particle sizes from 0.7 to 1.0 mm. All filter layers, except the middle one, have a constant height and gradually reducing and increasing pore sizes. The varying particle sizes of the filter layers increase the efficiency of thorough filtration of suspended solid particles from reservoir water. Because all the layers are compressed by the perforated discs on either side, the porosity of the working layer of the filter does not change under the pressure of the flow of water. The thickness of the variable-height granular filter was varied as follows: *h* = 50, 100, 200 and 300 mm.

During the experiments, samples of reservoir water from the aforementioned Uzen field, with suspended particles ranging from 1.8 to 3.2 g/l, were used. The main criteria for evaluation of the performance of the granular filter included the mass, in mg, of suspended particles in one liter of reservoir water (*C* g/l), and the maximum particle sizes of suspended particles, in microns, in the water before and after filtration.

The water containing suspended particles flows vertically from the lower compartment of the cylindrical apparatus to the top, passing sequentially through the layers of the granular filter. Due to the fact that the lower and upper layers of the granular filter have gradually decreasing particle sizes, the suspended solids do not clog in the filter spaces, instead, falling down to accumulate in the lower chamber. Water moving from the bottom freely passes through the pores of the filter, and then the filtered reservoir water is discharged through the outlet pipe. The mass of suspended solids in the reservoir water before and after treatment was determined by the standard method for passing water through filter paper and weighing the dried solids on a Shimadzu analytical balance.

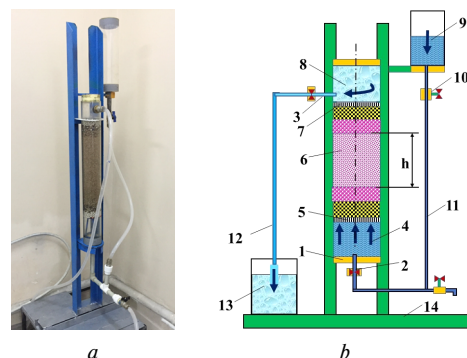

Fig. 5. General view (a) and schematic diagram (b) of an experimental installation for cleaning suspended solid particles from formation water

The results of this water treatment method showed that when the height h of the working layer of the filter increases, from 50 to 300 mm (Fig. 6, *a*), there is a significant decrease in the mass of solid particles in one liter of reservoir water (C g/l). Indeed, when the layer height h exceeds 80–100 mm, the value reaches zero very nearly. A further increase in the height of the granular filter above 300 mm was determined to be unnecessary.

Particle size was measured using the Zetasizer Nano versatile light scattering system, showing radius (r .nm) of solid particles, 1.8 g/l, in samples of formation water, both before and after filtration through a filter layer with a height of 50 mm. The results of these measurements showed that in the initial formation water, with suspended solids of 1.8 g/l, 45 % of the suspended solids (Fig. 6, *b*, upper graph) ranged from 500 to 800 nm. This range of suspended solids is commensurate with the sizes of pores and capillaries in typical reservoirs. Injection of water with such suspended solids into oil formations will gradually lead to a decrease in the permeability of the bottomhole zone and the effectiveness of injection wells. After filtration of the initial reservoir water through a filter with a height of 50 mm, 45 % of the solid particles (Fig. 6, *b*, lower graph) ranged from 90 to 100 nm, showing a marked decrease. This suggests that granular filters with a height of only 50 mm can significantly retain large solid particles, though if the height exceeds 100 mm, such filters can fully provide thorough cleaning of reservoir water.

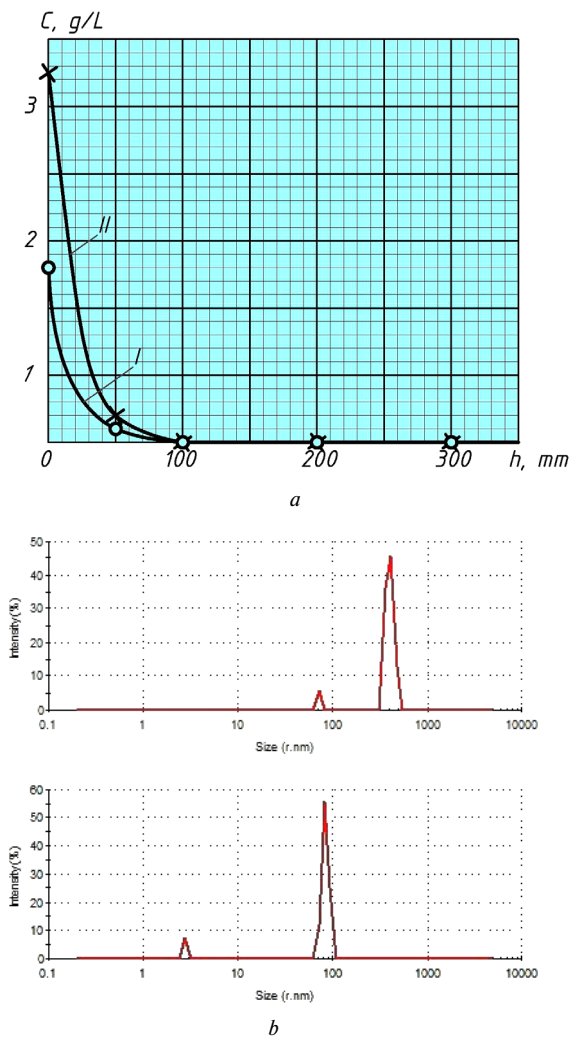

Fig. 6. Graphs showing the dependence of the concentration of suspended particles on the height of the filter (*a*) and the reduction in the size of suspended solid particles before and after filtering formation water containing suspended solid particles, 1.8 g/l, through the working layer of a filter with a height of 50 mm (*b*), measured using the Zetasizer Nano

A photo of a sample of solid particles remaining after the reservoir water was passed through a 50 mm filter is shown in Fig. 7, *a*. The mineralization of reservoir water was determined by evaporation of a known volume of liquid on a constant mass of filter paper, which was then weighed on the Shimadzu analytical balance. The analysis showed that the mineralization of formation water before filtration was 49 g per liter, which decreased to 35.6 g per liter after running the water through a granular filter with a height of 100 mm. A photo of a sample of salts obtained following evaporation of the reservoir water is shown in Fig. 7, *b*.

One of the most important parameters that determine the energy consumption of the filtration process is the resistance to the movement of reservoir water through the layers of the granular filter. With an increase in the height of the working layer of the filter, the power consumption of pumping units increases. In order to perform design calculations, knowing the coefficient of resistance to the movement of reservoir water through the granular filter is necessary. This coefficient of resistance to the movement of reservoir water through the filter can be determined based on Darcy's law, which shows the rate of water filtration in a porous medium is proportional to the pressure gradient (dp)

$$v = \frac{Q}{A} = k \frac{dp}{Lh}, \quad (2)$$

where Q is the volumetric water flow, v is the linear velocity of water movement through the granular filter; A is the cross-sectional area, $A = \pi d^2/4$ (d is the cross-sectional diameter of the filter); h is the filter height, and k is the coefficient of proportionality, or the reciprocal of the coefficient of resistance (ω) to the movement of water, through the filter ($\omega = 1/k$).

After integrating gradient pressure (dp) from atmospheric pressure (p_0) so as to calculate the excess pressure supplied by a pumping unit (p), the research team found the value of the coefficient of resistance (ω) to the movement of water through the filter is

$$Q = \frac{kA}{h} \int_{p_0}^p dp \quad \text{and} \quad Q = \frac{kA}{h} (p - p_0) = Q = \frac{A}{\omega h} (p - p_0),$$

then

$$\omega = \frac{A}{Qh} (p - p_0).$$

In order to determine the values of the coefficient of resistance to water movement, depending on the height of the granular filter layer, experiments were carried out using the previously described experimental setup. Volumetric water flow Q is expressed as the volume of water V over the time t that it flows through the filter. From a container with a height of 300 mm, located 50 mm above the level of the outlet of the filter housing, water flows at a constant rate Q . Time t was measured as the period that was necessary for the volume V of 5 liters of reservoir water to flow through filters with variable heights h of 50, 150, 250 and 350 mm. The resulting pressure difference ($p - p_0$) is determined through the density ρ of the

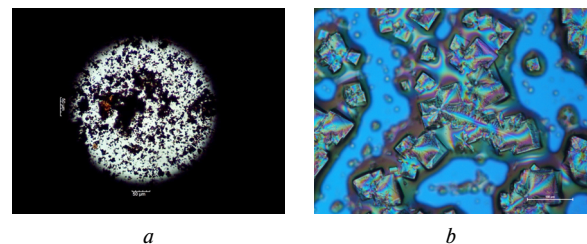

Fig. 7. Photos of samples of solid particles (*a*) obtained after passing reservoir water through a 50 mm filter, and salts (*b*) obtained following evaporation of reservoir water

Table 5

Values used in determining the coefficient of resistance (ω) to water movement through a filter with a variable-height granular layer

Parameter	Height h of the granular filter layer, mm			
	50	150	250	350
Water flow time through the granular filter, t (s)	100	301	503	708
Coefficient of resistance to water movement, ω (s · MPa/m ²)	30.5	30.6	30.7	30.9

water and the pressure head ($h_0 = 300$ mm), the original capacity of the water column, resulting in ρgh_0 , where g is the acceleration of the volume in free fall due to gravity. After measuring the time t of water flow through the granular filter, the values of the coefficient of resistance ω to the movement of water through the filter were calculated by the formula

$$\omega = \frac{A}{Qh} \rho gh_0 = \frac{A}{Vh} t \rho gh_0 = \frac{m^2 \cdot s}{m^3 \cdot m} = \frac{s}{m^2}. \quad (3)$$

Units used in measurements were in accordance with the SI system, including area in meters (m²), liquid flow rate in cubic meter/second (m³/s), length (m), and pressure in Pascals (Pa).

The results of the experiments to determine the measurement of the time t that the water took to flow through the granular filter and the calculated values of the coefficient of resistance ω to water movement are presented in Table 5 and Fig. 8. The graph shows that when the height h of the granular filter layer is changed from 50 to 350 mm, the time t that water needs to flow through the granular filter increases from 98 up to 700 seconds, while the coefficient of resistance ω to water movement also rises slightly from 30.5 to 30.9 s · MPa/m². Therefore, an increase in the height of the granular filter of 100 to 300 mm, so as to improve the reliability of the filtration process, does not lead to a significant rise in energy costs.

Formulas (2 and 3) demonstrate that an increase in the volume of the granular filter results in a rise in productivity, with the specific energy consumption of pumping units decreasing relative to water volume as the filter size is increased, because cleaner water requires less pressure. In this regard, when designing granular filters, the units should have large diameters.

Knowing the value of the coefficient of resistance ω to the movement of water through the granular filter, based on the

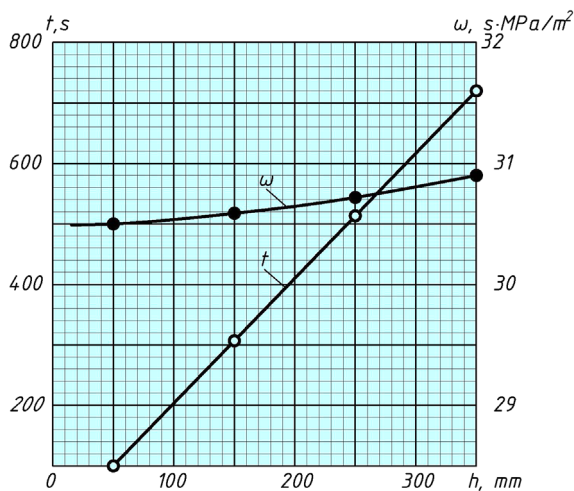

Fig. 8. Dependence of the time (t) of water flow and the coefficient of resistance (ω) to water movement based on the height (h) of the granular filter layer

experimental data, the pressure change Δp needed for a pumping unit to push formation water through a granular filter can be determined using the formula

$$\Delta p = \frac{Qh}{A} \cdot \frac{1}{k} = \frac{Qh}{A} \omega.$$

The performance of the granular filter can be assumed to be equal to that of the pumping unit in the reservoir water treatment system, thus the diameter and height of the granular layer can be altered, taking into account the coefficient of resistance ω . The height of the lower compartment of the filter housing is selected for the necessity of collecting the accumulated solid particles and their removal from the device. Whereas, the height of the upper compartment must take into account the necessity of minimizing resistance to the movement of vertical water flow.

Therefore, the results of the experimental study on reservoir water filtration in a granular filter with varying particle sizes show that with a small working layer height of at least 100 mm, using particles with a size of 0.6 to 0.8 mm, thorough cleaning of formation water from suspended solid particles is ensured. The use of such filters in a reservoir water treatment system to maintain reservoir pressure will significantly increase flow rates in production wells, estimated to be at least 1.5–2 times, by increasing the permeability of the oil reservoir and the effectiveness of injection wells.

Conclusions. In oil fields, formation water with suspended solid particles is used to maintain reservoir pressure after it has been processed in settling tanks. The sizes of suspended solids in water injected into oil reservoirs approximate those of the pores of reservoir rock, usually 0.8 to 1.0 microns or larger. Solid particles decrease the permeability of the bottomhole zone of the oil reservoir. At the same time, production well rates are usually reduced to 5 tons/day, or less.

The recommended method for thorough water filtration using a granular filter with varying particle sizes solves the problem of reduced permeability of the formation and improves the effectiveness of injection wells. Solid particles are filtered from water as it moves vertically through the filter, passing sequentially through granular layers with different-sized particles. Because particle size in the lower and upper layers of the granular filter gradually decrease and then increase, suspended solids do not clog the gaps in the filter, but instead, sink and accumulate in the lower part of the cylindrical unit.

The experimental studies conducted show that at an adjustable granular layer height of at least 100 mm, the quantity of suspended solid particles in the formation water practically reaches zero. In order to improve the reliability of the filter, the height of the granular layer can be increased to the range of 200 to 300 mm, and the diameter may be increased as well. The values of the coefficient of resistance to the movement of water through the filter were experimentally determined by varying the height of the granular layer, which allows for the calculation of the specific energy consumption of pumping units.

The use of such granular filters in formation water treatment systems so as to maintain reservoir pressure will significantly increase the efficiency of production wells, by an estimated 1.5 to 2 times, resulting in an increase in the permeability of reservoirs and enhanced flow from injection wells.

References.

1. Dairabai Zh. Abdeli, & Assel B. Seiden (2018). High Performance Water Treatment Technology For The Reservoir Pressure Maintenance At Oil Fields. *Journal of Mechanical Engineering Research and Developments*, 41(4), 66-81. <https://doi.org/10.26480/jmerd.04.2018.66.81>.
2. Dayrabay Zh. Abdeli, Wisup Bae, Assel B. Seiden, & Adi Novriansyah (2019). Development of effective technology of deep water treatment from suspended solid particles for formation pressure maintenance at the oil fields. *Journal of Mechanical Engineering Research and Developments*, 42(3), 24-29. <https://doi.org/10.26480/jmerd.03.2019.24.29>.
3. Liu He, Gao Yang, Li Guoxin, & Li Yiliang (2013). Simulation of Formation Damage after Long-Term Water Flooding. *Journal of Petroleum Engineering*, (5). <https://doi.org/10.1155/2013/479827>.

4. Mullayev, B. T., Abitova, A. Zh., Sayenko, O. B., & Turkpenbayeva, B. Zh. (2016). *Uzen deposit. Problems and Solutions: monograph.* (Vol. 1). Nur-Print.
5. Ivanovsky, V. N., Sabirov, A. A., Bulat, A. V., Degovtsov, A. V., Usenkov, A. V., Brezgin, A. R., ..., & Shevkun, A. M. (2014). Water purification systems for the needs of reservoir pressure maintenance and field oil treatment. *Territory "Oil and Gas"*, (10), 54-59. Retrieved from <https://www.neftegas.info/upload/iblock/a4a/a4ab40d013bc953d-36c2331f3cf1b079.pdf>.
6. Ivanovsky, V. N., Sabirov, A. A., Degovtsov, A. V., Bulat, A. V., Pekin, S. S., Meritsidi, I. A., ..., & Pyatov, I. S. (2015). Development of a separation unit and water treatment technology for a reservoir pressure maintenance system. *Territory "Oil and Gas"*, (3), 106-112. Retrieved from <https://tng.elpub.ru/jour/article/view/38/39>.
7. Mukhamadeev, R. U., & Voltsov, A. A. (2011). Investigation of the efficiency of formation water treatment by the method of vibroacoustic impact. *Oil and gas business*, (4), 91-95. Retrieved from http://ogbus.ru/authors/Mukhamadeev/Mukhamadeev_2.pdf.
8. Zentsova, A. Ye., Stolbov, I. V., Tarasov, M. Yu., Tashbulatov, I. A., Kim, A. V., & Klenova, I. V. (2014). Methodological approaches to the use of chemical reagents for oil preparation and oilfield wastewater treatment at fields at a late stage of development. *Oil industry*, (4), 92-95. Retrieved from <https://www.gtng.ru/upload/iblock/af3/15%20Zentsov.pdf>.
9. Akimenko, V. V., Perunov, R. Ye., Ostantov, N. A., Kozlov, S. A., Pashkevich, K. L., Nechaev, A. S., & Borisov, G. K. (2016). Increasing the degree of destruction of structural-mechanical barriers of the dispersed phase in the preparation of oil and water. *Scientific and technical bulletin OJSC "NC "Rosneft"*, (42), 66-70. Retrieved from https://www.rosneft.ru/upload/site1/document_publication/VRN_1_2016.pdf.
10. Golubev, I. A. (2013). Ways and solutions for the treatment of produced water for the reservoir pressure maintenance system. *Oil and gas business*, (3), 87-96. *Territory "Oil and Gas"*. Retrieved from http://ogbus.ru/files/ogbus/authors/GolubevIA/GolubevIA_1.pdf.
11. Busarev, A. V., Selyugin, A. S., Sheshegova, I. G., & Urmitova, N. S. (2015). Hydrocyclone water treatment plants for flooding oil-bearing horizons in order to increase their oil recovery. *Oil and gas business*, (4), 199-215. <https://doi.org/10.17122/ogbus-2015-4-199-215>.
12. Ramesh Chandra Yerramilli, P. L. J. Zitha, Sanjay Surya Yerramilli, & Pavel Bedrikovetsky (2013). A Novel Water-Injectivity Model and Experimental Validation With CT-Scanned Corefloods. *SPE European Formation Damage Conference & Exhibition*, 5-7 June, Noordwijk, the Netherlands, SPE-165194-MS. Retrieved from <https://www.adelaide.edu.au/directory/pavel.bedrikovetski?dsn=directory.file:fileid=data:id=35176:m=view>.
13. Kalantariasl, A., Burmester, C., Schulze, K., Storz, J., Küenckeler, S., You, Zh., ..., & Bedrikovetsky, P. (2018). Produced Water Re-Injection and Disposal in Low Permeable Reservoirs. *Journal of Energy Resources Technology, Transactions of the ASME*, 141(7). <https://doi.org/10.1115/1.4042230>.
14. Feia, S., Dupla, J.-C., Ghabezloo, S., Sulem, J., Canou, J., Onaisi, A., ..., & Aubry, E. (2015). Experimental investigation of particle suspension injection and permeability impairment in porous media. *Geomechanics for Energy and the Environment*, 3, 24-39. <https://doi.org/10.1016/j.gete.2015.07.001>.
15. Zhu, X., Ran, Ya., Guo, W., Gai, K., Li, Ya., Yan, C., & Ding, B. (2020). Optimization of reinjection treatment technology for oilfield wastewater in Longdong area. *E3S Web of Conferences*, 194, 04046. Retrieved from https://www.e3s-conferences.org/articles/e3sconf/pdf/2020/54/e3sconf_icaeer2020_04046.pdf.
16. Tale, F., Kalantariasl, A., & Malayeri, M. R. (2020). Estimating transition time from deep filtration of particles to external cake during produced water re-injection and disposal. *Particulate Science and Technology*, 39(3), 1-10. <https://doi.org/10.1080/02726351.2020.1713941>.
17. Alem, A., Elkawafi, A., Ahfir, N.-D., & Wang, H. Q. (2013). Filtration of kaolinite particles in a saturated porous medium: Hydrodynamic effects. *Hydrogeology Journal*, 21(3), 573-586. <https://doi.org/10.1007/s10040-012-0948-x>.
18. Feia, S., Dupla, J.-C., Ghabezloo, S., Sulem, J., Canou, J., Chabot, B., ..., & Aubry, E. (2017). An Experimental Setup with Radial Injection for Investigation of Transport and Deposition of Suspended Particles in Porous Media. *Geotechnical Testing Journal*, 40(6). <https://doi.org/10.1520/GTJ20160032>.
19. Beisembetov, I. K., Abdeli, D. Zh., & Karabalin, U. S. (2018). *Method for purification of industrial, waste, reservoir waters with suspended solid particles and biological microorganisms.* (Patent No. 32696 RK MCI V11/00). Republic of Kazakhstan.

Підготовка пластової води на нафтових родовищах із застосуванням зернистих фільтрів зі змінними розмірами частинок

Д. Ж. Абделі¹, Вусан Бай², А. Б. Сейден¹, Аді Новренсіах³

1 – Satbayev University, м. Алмати, Республіка Казахстан, e-mail: assel_seiden@mail.ru

2 – Департамент розробки мінеральних ресурсів, Sejong University, м. Сеул, Республіка Корея

3 – Кафедра нафтової інженерії, Universitas Islam Riau, м. Пеканбару, Республіка Індонезія

Мета. Збільшення нафтовіддачі пластів, зниження обводненості, зменшення витрат за допомогою закачування ефективно очищеної від зважених твердих часток води пласта дозволяє отримати картину про рівномірний розподіл води по пласту, і в цілому про якісну підтримку пластового тиску продуктивних пластів.

Методика. Дослідження питань підготовки води для підтримки пластового тиску на існуючих нафтових родовищах має різноманітні підходи. Тому в роботі були використані методи аналізу, огляду, порівняння, моделювання, експерименту. Метод аналізу дозволив розділити проблематику підходів до підготовки пластової води для закачування її у пласт на безліч елементів, що дозволило вивчити їх властивості, зв'язок і стосунки. Цей метод сприяє детальній структуризації проблеми підготовки води. При аналогії використовується вивчення технології підготовки пластової води зі зваженими твердими частинками. На основі даних була вивчена ефективна технологія очищення пластової води від зважених твердих частинок і закачування її до продуктивного пласту.

Результати. Проведені експерименти відображають якісну підготовку води за допомогою розробленого нового промислового піщано-гравійного фільтру із зернистих матеріалів зі змінними розмірами частинок у вертикальному напрямі з урахуванням раціональних параметрів висоти стовпа робочої зони фільтру. Вивчені закономірності та удосконалено процес підготовки пластової води без зважених твердих частинок на основі проведених теоретичних і експериментальних досліджень на спеціальній лабораторній установці. Визначена залежність проникності пласта у привибійній зоні нагнітальних свердловин від розмірів твердих зважених частинок у воді, що закачується, а також встановлені раціональні параметри фільтру для підготовки води, що закачується без зважених твердих частинок у пласт із застосуванням зернистих матеріалів зі змінною фракцією й поданням води знизу нагору.

Наукова новизна. Пропонується ефективна технологія глибокого очищення пластової води від зважених глинистих частинок шляхом застосування фільтрів із зернистих матеріалів зі змінною крупністю частинок. Технічним результатом винаходу є підвищення ефективності очищення промислових стічних і промислових пластових вод зі зваженими твердими частинками.

Практична значимість. Запропоновано новий метод глибокого очищення пластової води, що забезпечує уловлювання твердих зважених частинок. Представлені результати дослідів зі встановлення закономірності процесу фільтрації пластової води зі зваженими глинистими частинками через пористе середовище зі змінними розмірами пор і зернистих частинок. Розроблені рекомендації із вибору раціональних параметрів і режимів роботи нового фільтру для підготовки пластової води.

Ключові слова: нафтові пласти, вода, очищення, фільтр, зернистий матеріал, свердловина

The manuscript was submitted 28.06.21.