

**G. Akanova**<sup>1</sup>,  
 orcid.org/0000-0002-7182-0386,  
**A. Sładkowski**<sup>2</sup>,  
 orcid.org/0000-0002-1041-4309,  
**S. Podbolotov**<sup>3</sup>,  
 orcid.org/0000-0002-7870-7183,  
**A. Kolga**<sup>4</sup>,  
 orcid.org/0000-0002-3194-2274,  
**I. Stolpovskikh**<sup>1</sup>,  
 orcid.org/0000-0003-2893-5070

1 – Satbaev University, Almaty, the Republic of Kazakhstan,  
 e-mail: [kairatguldana8@gmail.com](mailto:kairatguldana8@gmail.com)  
 2 – Silesian University of Technology, Katowice, the Republic  
 of Poland  
 3 – Nosov Magnitogorsk State Technical University, Magni-  
 togorsk, Russian Federation  
 4 – Ural State Agrarian University, Yekaterinburg, Russian  
 Federation

## WAYS TO REDUCE HYDRAULIC LOSSES IN MULTISTAGE CENTRIFUGAL PUMPING EQUIPMENT FOR MINING AND OIL-PRODUCING INDUSTRIES

**Purpose.** To study hydraulic losses in pumping units during pumping and transportation of liquids, to develop the design and technology solutions to improve the energy efficiency of centrifugal pumps in the mining and oil-producing industries.

**Methodology.** In the theoretical and experimental analysis of hydraulic losses during the transportation of liquids, the hydraulics and experimental analysis methods were used.

**Findings.** As a result of the research carried out, a new design scheme of a multistage centrifugal pump has been developed, providing a coaxial arrangement of impellers, which allows reducing hydraulic losses in pump elements and increasing the energy efficiency of pumping units.

**Originality.** Based on the analysis of existing designs of multistage blowers of axial and centrifugal types, the distribution of hydraulic losses in the elements of a centrifugal blower with coaxial impellers is considered. Experimental dependences on the establishment of pressure flow and power characteristics are presented. Based on the accounting of hydraulic losses, the energy efficiency of the design of the pumping unit with the coaxial arrangement of the impellers was assessed.

**Practical value.** The new design of a centrifugal pump with coaxial impellers reduces hydraulic losses by more than 23 % compared to traditional designs of centrifugal pumps. The results of the work can be used by design, research, and industrial organizations engaged in the design and operation of pumping equipment.

**Keywords:** *hydraulic transport systems, centrifugal pump, hydraulic losses, coaxial arrangement of impellers*

**Introduction.** The urgent task of an efficient economy is the rational use of energy resources. The solution to this problem is associated with an increase in energy efficiency and the implementation of energy-saving measures in the production, transmission, distribution, and conversion of electrical energy into other types of energy, depending on the characteristics of certain technological industries. To achieve these goals, it is necessary to develop effective measures in the field of energy, power supply, and electric drive.

The energy efficiency of a technological process is understood as the minimum allowable amount of energy required to produce products of a given quality in compliance with technical safety standards. Increasing energy efficiency, eliminating excessive energy consumption, are associated with scientific and technical substantiation of energy consumption rates in the adopted production technology and the development of new technologies that reduce specific energy consumption and improve product quality. The development of methods and means for increasing the efficiency of energy use requires an analysis of existing technologies and operating modes of equipment.

To improve efficiency, it is necessary to reduce the operating cost of pumping equipment, improve its reliability and durability. This requires optimization of the operating modes of already operating centrifugal pumps and the creation of new highly efficient machine designs [1].

This issue has received the greatest development in the industrially developed countries of Europe, where the need for the production of energy-efficient pumping equipment is enshrined at the legislative level. Since 2009, there has been a regulation of the European Commission in force, which specifies the energy efficiency requirements for circulation pumps up to 2500 W.

In the CIS countries, the problem of energy efficiency and energy saving is especially acute due to the high specific energy intensity of the main energy industries. Despite the efforts made, the real reduction in the energy intensity of production is taking place at a low rate. This is largely due to the underdeveloped complex approach to solving the problem [2].

Mining and oil-extracting industries are among the most energy-intensive types of production [3, 4]. The main consumers of energy in these industries are injection installations for the movement of liquid and gaseous media. Their electricity consumption is about 75–80 % of the total energy consumption of the enterprise as a whole.

The traditional areas of their use are pneumatic installations (energy transmission using compressed air), ventilation (fresh air supply to ventilate mines and work-places), and pumping installations (industrial water supply, groundwater removal, transportation of slurries, and oil products).

According to expert estimates, 20–25 % of the world's electricity consumption falls on pumping equipment, and in some industries, this figure can reach 50 %. According to the data of large oil companies, energy costs for the system for maintaining reservoir pressure in wells are up to 40 %, and for high-viscosity heavy oil, this figure is much higher. In this regard, the problem of increasing the energy efficiency of pumps should be considered not just as a priority, but as a strategic and state one.

Most of the pumps currently produced were developed more than 30 years ago and no longer meet modern production efficiency requirements.

Those manufacturers who invest in the modernization of production and pump designs are more successful in competing in the world pumping equipment market.

**Literature review and unsolved aspects of the problem.** A promising direction for modernizing pump designs is to improve the geometry of the impeller since both the efficiency of the pump (its energy efficiency) and the hydrodynamic loads

on the rotor of the hydraulic machine (the service life of the pump) depend on the nature of the fluid flow of the flow path, the impeller of the pump.

The solution to the problems of increasing energy efficiency, in particular the efficiency of centrifugal pumps, is achieved by carrying out the procedure of parametric optimization at the stages of analysis and synthesis of the structure. The existing and used methods in the practice of designing elements of dynamic pumps – impellers (impellers), augers, inlet, guide, and outlet devices give acceptable results, but do not provide the determination of the optimal parameters that provide high indicators of energy efficiency, resource, and reliability.

This area includes works devoted to the numerical modeling of non-stationary flows in centrifugal pumps [5] in which a formalized approach to the optimization of centrifugal pumps is given, taking into account the turbulence of the fluid flow caused by the rotation of the impellers in a fixed casing. It is noted that in order to optimize such machines, it is necessary to analyze in detail the time-dependent hydraulic flow.

Flow modeling using computational fluid dynamics (CFD) allows one to do this. The authors provide a program with which to solve partial differential equations to establish the mass and momentum of the hydraulic flow. The results of the studies performed have shown that, in comparison with the use of average flow values, optimization by adjusting the head and pressure makes it possible to increase the efficiency of the pump by up to 20 %. It is noted that the presented model can be a useful tool for the analysis and selection of a rational rotation speed of existing centrifugal pumps, as well as for the design of new machines.

Of interest is the work [6], it gives an idea of the instability of centrifugal pumps during transient processes performed in cavitation conditions at start-up and constant pump rotation speed. It is noted that it is very useful for identifying the internal non-stationary transient mechanism in the flow system in a centrifugal pump, which is of great theoretical importance for ensuring reliable and stable operation of the hydraulic transport system.

Based on the research results, the authors proposed a conditional division of hydraulic flow oscillations into three types. The first type includes large-scale low-frequency fluctuations in hydraulic flow at high flow rates. To the second, fluctuations at low flow rates with a drop in pressure at the end of the start-up process. The third type of pressure change is associated with changes in which low cavitation values are provided at the end of the pump start-up, and an increase in the flow rate leads to more developed cavitation conditions, which in turn causes a constant drop in the pump head.

In work [7], the authors model the asymmetric pressure distribution and its fluctuations in a centrifugal pump.

The processing of the results of experimental studies by the authors was carried out on the basis of the fast Fourier transform. It was revealed that the amplitude of pressure fluctuations and the frequency of passage of the pump blades are sensitive to the flow rate of the fluid. It is noted that as the flow rate increases, both the asymmetry in the pressure distribution and the pressure value decrease.

With regard to this work, the research [8, 9] devoted to the study on the reasons for the change in the productivity of centrifugal pumps with a decrease (trimming) of the impeller diameter is of considerable interest. As the diameter of the impeller decreases, its geometric parameters change the diameter of the impeller, the angle of coverage of the blades, the width at the inlet of the impeller, and the angle of inclination of the impeller.

The reliability of the research results was confirmed by comparing the experimental and numerical results. The results show that in numerical simulations, they are slightly higher than in experimental ones, due to neglect of volumetric leakage losses through balancing holes and mechanical seals caused by mechanical seal and bearings. Analysis of the results

of calculations using CFD technology made it possible to draw the following conclusions. With a decrease in the impeller diameter by 15 mm, the pump flow rate is reduced by 20 cubic meters.

When centrifugal pumps are not fully loaded, the pump impeller may experience internal energy dissipation due to flow separation and fluid vortices. In order to establish the characteristics of the processes of dissipation of the internal energy of a centrifugal pump with a partial load, the authors of the article [10] investigated the unsteady nature of such operating modes.

Operational experiments and wall transient pressure measurements were performed to verify the results. A methodology for analyzing the dissipation of internal energy is proposed; unsteady pressure fluctuations in a rotating impeller were analyzed.

Internal power losses were observed in the centrifugal pump mainly in the volute and impeller. The rotational stall phenomenon occurred with separation of the flow during partial load operation, which led to the dissipation of internal energy in the impeller. The rotating impeller experienced low frequency pressure fluctuations under partial load conditions, while under design operating conditions it experienced only rotational speed.

Similar issues are raised in papers [11, 12] devoted to the study on energy dissipation associated with the phenomenon of unsteady flow inside the impeller of a centrifugal pump under overload conditions. In this case, a 3D unsteady numerical simulation of the pump was performed using the curvature-corrected turbulence model SAS SST with the total energy equation. As a result of unsteady modeling, it was found that a high-energy vortex flow is periodically generated and peeled off, which causes losses of hydraulic energy in conditions of overload operation.

Analysis of work in the direction of hydroabrasive wear of the flow parts of dredge pumps, in general, reveals an increased interest in this problem. It should be noted that due to the lack of a unified theory of hydroabrasive wear of the working surfaces of centrifugal pumps, the development of these studies occurs through the accumulation and multiplication of studies for various types of abrasive and surface wear, so in [13, 14] the relationship between the wear rate of the impeller surfaces, and the snail was investigated using the wear rate distribution.

It has been established that the main reasons for the dissipation of the internal energy of the pump impeller under the conditions of its operation at partial load are the separation of the flow of fluid near the impeller casing and rotating stall.

As a result of the performed studies on the two-phase flow “liquid-solid”, it was found that the relative wear rate of the impeller is higher when the pump operates at low flow rates compared to wear when the pump is operating at full load. Therefore, it is not recommended to use centrifugal pumps in low flow conditions.

In [15], the authors investigated the relationship between the stiffness of the bearings of centrifugal pumps and the speed of rotation of the shaft in order to establish the vibration characteristics of the pumps. It was found that the critical shaft rotation speed increases with an increase in the bearing stiffness, and the intrinsic axial and torsional rotational speed of the shaft changes little, but the lateral shaft rotational speed varies greatly.

Studies devoted to the issues of new designs of pumps used as mixers with kaoxial and non-kaoxial impellers are given in many works.

The work [16] presents the results of studies to establish the influence of the modes of rotation of the shafts of kaoxial mixers on the drive power. It was found that, in comparison with the opposing mode, the kaoxial mixer operating in the joint rotation mode turned out to be more energy efficient due to a decrease in the drive power per unit volume.

In [17], the results of the analysis of the arising stresses and strains in the internal structure of a stepped coaxial attenuator are presented, which are made with the aim of increasing their performance and durability. The places of stress concentration are in the structures of attenuators in which microcracks can appear, which gradually grow and lead to breakdowns of structural elements.

To solve the problems of imbalance in the supply and production of a low production oil well, low pump efficiency and low system efficiency, a small displacement pump with a non-coaxial injection valve was designed [18, 19].

The content of methods for designing impellers of centrifugal pumps are described in [20, 21], which present mathematical models used for the numerical study on stiffness and damping in the analysis of the dynamics of pump structures, which provide the basis for their design. Combining operating experience and the latest developments in the field of pumping technology, a new type of impeller was developed – the “curved impeller”. This new type of impeller can be used in existing high-efficiency pumps without any modifications and will provide better suction and reduced wear characteristics of the impeller of a centrifugal pump.

Despite the significant amount of research on this problem, the considered problem of substantiating the design improvements of hydrotransport systems still does not have a comprehensive solution. A comprehensive solution to the problem of increasing the energy efficiency of pumps requires not only constructive improvements of the working parts, but also the rationalization of the operating modes of the pumping equipment of hydrotransport systems.

To solve these problems, design organizations are required to perform a thorough calculation of all technological parameters of the production process and the selection of technological equipment. This is especially true for the selection of centrifugal pumps, for which optimal operation is a determining factor affecting the service life and energy efficiency of hydraulic transport systems.

In connection with the development of the established resource and obsolescence of technological equipment, at present the main reason for failures in the operation of hydraulic transport systems is the low mechanical reliability of working devices. For this reason, up to 80 % of accidents and equipment failures occur, a third of which are attributable to dredge pumps. Wear of impellers, in turn, causes significant vibration stresses transmitted to the support units of the pumping unit – bearings, whose service life is sharply reduced and leads to a decrease in efficiency [21].

The analysis of the operating modes of existing pump designs still shows shortcomings, the presence of which is not acceptable in modern production conditions. These disadvantages are expressed in the form of a narrow range of effective operation, low energy efficiency at off-design operating modes, and low hydraulic efficiency of structures.

The existence of these shortcomings is largely due to the design of the installations, namely, the presence of elements with high values of hydraulic losses (Table).

As can be seen from the data in the table, impellers and transfer channels have the highest values of hydraulic losses.

Table

Distribution of energy losses in pump elements

Flow section	Share of total losses, %
Working wheel	45–50
Spiral ducts	10–15
Diffuser ducts	10
Translation channels	20
Return channels	10

Losses in the impeller, in turn, are the sum of friction losses and vortex losses of the steady-state relative motion. Losses from vortex formation of unsteady motion, as well as losses of hydraulic braking, are due to the mutual influence of the impeller and the diverting devices. The share of these losses at the design operating mode of the installation is insignificant; however, in the case of deviations from the design operating mode of the impeller, the share of these hydraulic losses increases very strongly.

Losses in the transfer channels (Figs. 1, 2) [22, 23] consist of friction and vortex losses. The occurrence of vortex formation phenomena is due to the specifics of the flow in the diverting devices. As can be seen from the presented diagram, the flow movement in multistage installations has a complex spatial character, characterized by a constant change in the direction of the fluid flow. In this case these phenomena are accompanied by large hydraulic losses due to shocks and eddies. The value of the total hydraulic losses due to shocks and eddies is about 2–3 % of the value of the hydraulic efficiency [24].

Increasing the energy efficiency of these designs of centrifugal plants, due to existing methods, is possible only in a small range, determined only by eliminating the influence of one of the factors. For a significant change in energy efficiency indicators, an integrated approach is required to solve this problem. As an alternative to the existing designs, a centrifugal pump design with a coaxial arrangement of impellers can become, which allows the transfer of energy from stage to stage, without the use of transfer channel systems. A scheme of such a supercharger is shown in Fig. 3.

The purpose of this research is to substantiate the possibility of creating a new design and technological scheme of a centrifugal pump with a coaxial arrangement of impellers, which ensures the transfer of hydraulic energy from stage to stage without transfer channels, which will reduce hydraulic losses, increase the efficiency and energy efficiency of the pump.

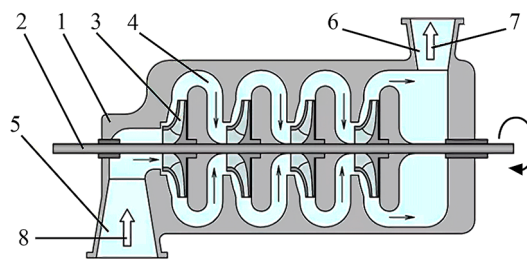

Fig. 1. Scheme of flow movement in a 4-stage centrifugal pump with channel outlets:

1 – body; 2 – shaft; 3 – impeller; 4 – transfer channel; 5 – supply device; 6 – diverting device; 7, 8 – fluid flow

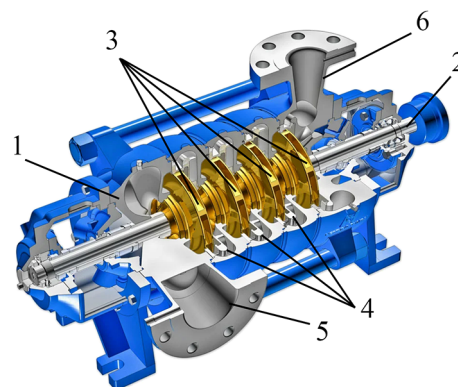

Fig. 2. General view of a 4-stage centrifugal pump:

1 – body; 2 – shaft; 3 – impeller; 4 – transfer channel; 5 – supply device; 6 – diverting device



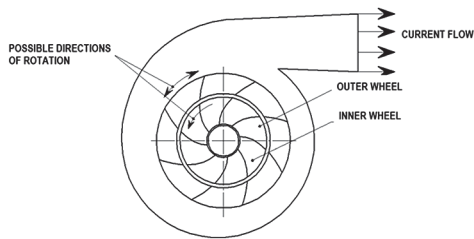

Fig. 3. Scheme of a two-stage centrifugal blower

The formulation of the research problem is to substantiate rational geometrical and kinematic parameters of the design and technological scheme of a centrifugal pump with coaxial impellers and to identify patterns of change in hydraulic losses in the impellers of such pumps.

**Statement of the main material. Experimental studies.** The results of experimental studies on a two-stage centrifugal pump with a coaxial arrangement of impellers, the design of which is shown in Fig. 4, made on the basis of a monoblock pump IXM-2-2v, showing its efficiency, are presented in the form of graphical dependencies (Fig. 5).

In the course of the experimental studies, the change in the head value was 28 % of the maximum value (from 1.3 to 1.8 kg/cm<sup>2</sup>), the change in the flow rate was 42 % (from 2 to 3.5 m<sup>3</sup>/s), without significant changes in the power characteristic, and hence the power consumption.

A diagram of the design of coaxially mounted impellers of a two-stage centrifugal pump and an impeller of a standard design are shown in Fig. 6 [24].

The basis for the development of this alternative scheme was the scheme that is currently widely used in axial multistage installations (Fig. 7).

In this scheme, the movement of the flow from one impeller to another is carried out using vane guide vanes, whose efficiency is characterized by low values of hydraulic losses. In designs with counter-rotating impellers, the use of guide vanes is not required at all.

In addition to establishing the pressure-flow and power characteristics, an assessment of the energy efficiency of the pumping unit in this design is required.

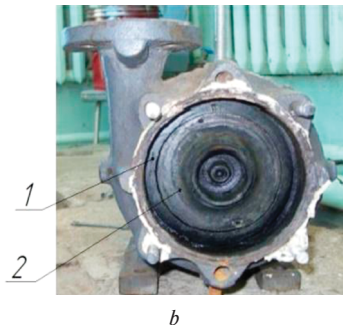

Fig. 4. Design of a centrifugal pump with coaxial impeller arrangement:  
1 – external impeller; 2 – internal impeller

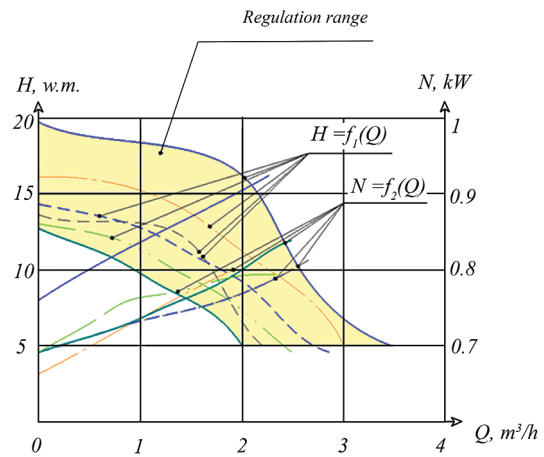

Fig. 5. Pressure-flow  $H = f_1(Q)$  and power  $N = f_2(Q)$  characteristics of a centrifugal pump with coaxial impellers:

— Original impeller  $d = 128$  mm; - - - Turned impeller  $d = 107$  mm; - - - Coaxially mounted outer impeller with an angle of inclination of the blades  $< 90^\circ$ ; - - - Braked coaxially mounted outer impeller with blade angle  $< 90^\circ$ ; - - - An external impeller is installed coaxially with an angle of inclination of the blades  $> 90^\circ$ ; — Braked coaxially mounted outer impeller with blades inclination angle  $> 90^\circ$

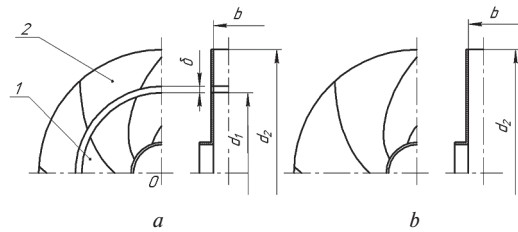

Fig. 6. Centrifugal pump:  
a – standard design; b – with coaxial arrangement of impellers: 1 – inner impeller; 2 – outer impeller;  $\delta$  – radial clearance; b – impeller width,  $d_1$ ,  $d_2$  – outer diameters of inner and outer impellers

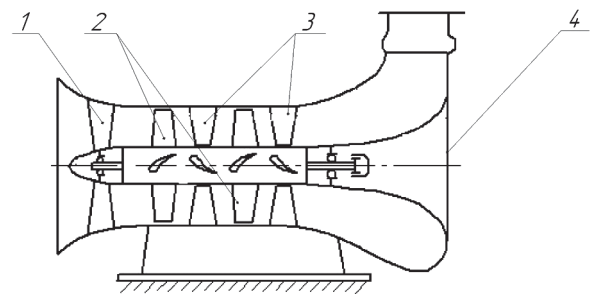

Fig. 7. Diagram of a two-stage axial blower:  
1 – inlet guide vanes; 2 – impellers; 3 – straightening devices; 4 – blower housing

Efficiency assessment is carried out on the basis of an assessment of the losses of useful energy of the fluid flow in the casing and the main moving elements of the pump.

Losses in the flow path of a centrifugal pump with coaxial impellers can be divided into four categories: volumetric, disk friction, hydraulic and hydraulic braking losses. In the design (rational) mode, the loss of hydraulic braking, as a rule, is absent, and the total efficiency can be determined based on the ratio

$$\eta = \eta_h \cdot \eta_v \cdot \eta_{d_s} \quad (1)$$

where  $\eta_h = \frac{H}{H_t}$  is hydraulic efficiency;  $H$  is obtained head value;  $H_t$  is theoretical head value;  $\eta_v = \frac{Q}{Q + q_1}$  is volumetric

efficiency;  $q_1$  is leakage through the front impeller seal;  $Q$  is fluid flow rate;  $\eta_d = 1 - \frac{N_d}{N}$  is internal mechanical efficiency;  $N_d$  is total power loss due to disk friction;  $N$  is power consumption.

Based on the design features of the coaxial arrangement of the impellers (Fig. 4), namely the identity of the total dimensions of the coaxially located impellers to the dimensions of the impeller of a standard design, the values of the volumetric and mechanical efficiency will remain unchanged. Only the hydraulic efficiency and the corresponding hydraulic losses are subject to consideration.

Hydraulic losses are the most difficult from the point of view of their theoretical and experimental study. The main reason for this is the complexity of the physical processes occurring in centrifugal pumps. Hydraulic losses in the flow path of centrifugal pumps depend on the shape and size of its elements, operating modes of the installation, the nature of the flowing flow, and so on.

Any vane machine, including the centrifugal type, can be considered as a combination of stationary and rotating channels and profiles of various lengths and shapes connected in series with each other, and each of them has quite definite hydraulic resistances.

Hydraulic losses in the flow path of a centrifugal pump can be represented as

$$\sum h = h_s + h_i + h_{tap} = \xi_s \frac{V_{11}^2}{2g} + i \frac{W_{11}^2}{2g} + \xi_{tap} \frac{U_{22}^2}{2g}, \quad (2)$$

where  $h_s$ ,  $h_i$ ,  $h_{tap}$  are supply losses, in the impeller and out of the tap;  $V_{11}$ ,  $W_{11}$ ,  $U_{22}$  are characteristic velocities in the elements of the flow path of a centrifugal supercharger;  $\xi_s$ ,  $\xi_i$ ,  $\xi_{tap}$  are coefficients of local hydraulic losses in the inlet, impeller and outlet;  $g$  is acceleration of gravity.

Due to the fact that the absolute velocity of the flow of fluid entering the impeller blades is approximately equal to the relative velocity of the fluid flow, when calculating the hydraulic losses in the flow path of a centrifugal pump, the losses in this element can be neglected.

Only losses in the impellers themselves and losses in diverting devices are subject to consideration.

**Results. Impellers.** Hydraulic losses in impellers (external and internal) are of the same nature, obey the same laws, the only difference is in the relative direction of rotation of the impellers themselves, and the corresponding difference in the set of defining dependencies of hydraulic losses of the external stage.

The impellers are rotated in two possible modes (Fig. 8):  
1) rotation of the impellers in one direction (Fig. 8, a);

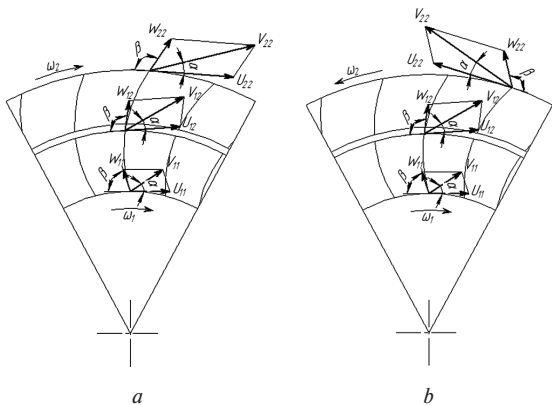

Fig. 8. Plan of speeds of impellers of a centrifugal pump with coaxial arrangement of impellers, depending on the direction of their rotation:

a – when the impellers rotate in one direction; b – when the impellers rotate in opposite directions

2) rotation of the impellers in opposite directions (Fig. 8, b).

The losses in the inner impeller are identical to those in the standard impeller, since the direction of rotation does not change, and there is no influence on the flow movement from the outer impeller in it.

Consequently, the total hydraulic losses in the internal impeller will consist of the following types of losses:

- losses from turning the fluid flow from the axial direction to the radial direction

$$h_{11} = \xi_1 \frac{V_{11}^2 + W_{11}^2}{2g}, \quad (3)$$

where  $\xi_1$  is the coefficient of local hydraulic losses;  $V_{11}$  is absolute flow rate of the fluid;  $W_{11}$  is relative flow rate of fluid at the inlet to the impeller;

- friction losses along the channel length

$$h_{12} = \frac{C_f W_{av}^3}{Qg} \left[ z b_{av} \cdot l + \frac{\pi}{4} (D_2^2 - D_1^2) \right], \quad (4)$$

where  $C_f$  is the coefficient of friction of the impeller blade surface;  $W_{av}$  is the average value of the relative flow rate;  $z$  is the number of impeller blades;  $b_{av}$  is the average impeller width;  $l$  is an impeller blade length;  $D_2$  – impeller outer diameter;  $D_1$  is the inner diameter of the impeller;

- losses from deceleration of fluid flow with decreasing relative velocity

$$h_{13} = \xi_3 \frac{(W_{11} - W_{22})^2}{2g}, \quad (5)$$

where  $\xi_3$  is the coefficient of local hydraulic losses;  $W_{11}$  is the relative flow rate of fluid at the inlet to the impeller;  $W_{22}$  is the relative flow rate of fluid at the outlet of the impeller.

Losses in the outer stage will be determined by the direction of rotation of this impeller with respect to the outer one, as well as by the value of its relative rotation speed.

**Total hydraulic losses of the external stage:**

- friction losses along the channel length.

In view of the previously indicated identity of the total dimensions of the coaxially installed impellers to the dimensions of the impeller of a standard design, the considered type of losses will be identical to the losses in an impeller of a standard design;

- losses from deceleration or acceleration of the fluid flow when the relative velocity changes at the entrance to the external stage

$$h_{22} = \xi_2 \frac{(W_{12} \pm W_{21})^2}{2g}, \quad (6)$$

where  $\xi_2$  is the local hydraulic loss coefficient;  $W_{12}$  is the relative flow rate of the fluid at the exit from the first impeller;  $W_{21}$  is the relative flow rate of the fluid at the entrance to the second impeller.

This type of losses with the coaxial arrangement of the impellers will vary depending on the direction of rotation of the impellers:

- when the impellers rotate in one direction, but with different rotation speeds, this indicator will change both up and down, the magnitude of the change will correspond to the magnitude of the change in the relative flow velocity on the blades of the outer stage;

- when the impellers rotate in opposite directions, this type of losses will increase, regardless of the relative flow velocity in the outer stage, since the relative velocities will be summed up;

- losses from the transition of the fluid flow from the inner stage to the outer

$$h_{23} = 1 - \frac{W_{12}^2}{U_2^2 \pm U_1^2} \left( \frac{\sum \delta_b}{t_2 \sin \beta_2} + \frac{\sum \delta_d}{b_{k1}} \right), \quad (7)$$

where  $\sum \delta_b^{**}$  and  $\sum \delta_d^{**}$  are the thickness of the impulse loss, respectively, on the blades and disks;  $b_{k1}$  is the outer impeller width;  $U_2$  is portable speed at the entrance to the outer impeller;  $U_1$  is portable speed at the outlet of the inner impeller;  $t_2$  is the width of the interscapular channel of the inner impeller.

**Results. Discharge devices.** Due to the absence of portable motion, the losses in the fixed elements of the flow path of a centrifugal blower with the coaxial arrangement of the impellers, which are also the outlets, can be compared with the well-studied losses in fixed channels of one shape or another and determined by the usual formulas of hydraulics [12].

**Spiral bend:**

**- total losses in the spiral bend**

$$h_{tap} = h_{sp} + h_{diff} = \xi_{tap} \frac{V_{22}^2}{2g}, \quad (8)$$

where  $h_{sp}$  is volute loss;  $h_{diff}$  is diffuser channel loss;  $\xi_{tap}$  is the coefficient of total losses in the spiral bend;  $V_{22}$  is the circumferential component of the absolute flow rate of the fluid at the outlet from the outer impeller;

$$\xi_{tap} = \xi_{sp} + \xi_{diff} \left( \frac{V_r}{V_{22}} \right)^2, \quad (9)$$

where  $V_r$  is the radial component of the absolute flow rate of the fluid at the exit from the outer impeller;  $\xi_{sp}$  is the spiral bend loss factor;  $\xi_{diff}$  is the diffuser channel loss factor.

**- friction losses in the volute** are determined on the assumption that it is a circular pipe of variable cross-section, in which the flow flows at a constant average velocity equal to the velocity in the design cross-section A-A (Fig. 9).

$$h_{vol.fr} = \frac{\lambda_{sp} \frac{V_r^2}{2g} \int_0^{R_\phi} \frac{R_\phi}{2r_\phi} Q_\phi \cdot d\phi}{Q}, \quad (10)$$

where  $\lambda_{sp}$  is the volute friction loss coefficient;  $j$  is the spiral angle;  $r_\phi$ ,  $R_\phi$  is the current radii of the snail-shaped body;  $Q_\phi$  is the current value of the flow rate of the fluid through the outlet section.

After a series of substitutions and transformations, the above equation takes the form

$$h_{vol.sp.} = \frac{\pi}{2} \lambda_{sp} \left( 1.17 \frac{D_2}{\sqrt{F_p}} + 1 \right) \frac{V_r^2}{2g}, \quad (11)$$

where  $V_r$ ,  $F_r$  are the speed and area of the calculated section of the spiral, respectively;

**- losses due to vortex formation in the spiral**

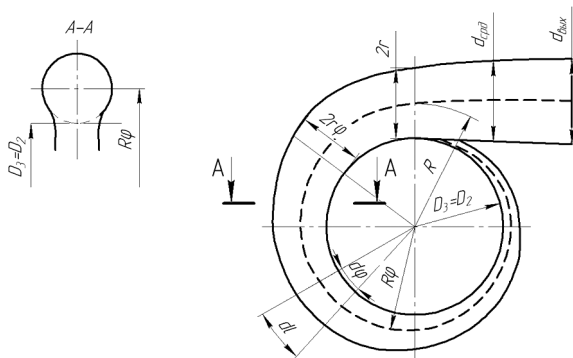

Fig. 9. Scheme for calculating losses in the spiral bend

$$h_{vort.sp.} = \frac{(V_{22} - V_r)^2}{2g}, \quad (12)$$

**- the total losses in the spiral are represented by the expression**

$$h_{sp} = \zeta_{sp} \cdot \frac{V_{22}^2}{2g}, \quad (13)$$

where  $\zeta_{sp}$  is the total loss factor in the volute.

**In a conical diffuser, there are two types of losses:**

**- friction loss**

$$h_{diff.fr.} = \frac{\lambda_{diff}}{8 \sin(E_{diff}/2)} \frac{(n^2 - 1) V_r^2}{n^2 \cdot 2g}, \quad (14)$$

where  $\lambda_{diff}$  is the coefficient of friction in the diffuser ( $\lambda_{diff} = 0.0102 - 0.017$ );  $E_{diff}$  is the expansion angle of the conical diffuser;  $n$  is the ratio of the areas in the calculated section of the spiral (section A-A Fig. 9) and at the exit from the conical diffuser

$$n = F_{out}/F_r, \quad (15)$$

where  $F_{out}$  is the outlet area of the diffuser;  $F_r$  is the cross-sectional area of the diffuser at the design cross-section;

**- losses from stream expansion**

$$h_{ext.diff.} = \sin E_{diff} \frac{(n-1)^2 V_r^2}{n^2 \cdot 2g}, \quad (16)$$

**- total losses in the diffuser**

$$h_{diff} = h_{fr.diff.} + h_{ext.diff.} = \zeta_{diff} \frac{V_r^2}{2g}, \quad (17)$$

where  $\zeta_{diff}$  is the total loss coefficient in the conical diffuser.

After substituting the components in the above expressions, the total loss factor in the diffuser can be determined

$$\zeta_{diff} = \frac{\lambda_{diff}}{8 \cdot \sin(E_{diff}/2)} \cdot \frac{(n^2 - 1)}{n^2} + \sin E_{diff} \frac{(n-1)^2}{n^2}. \quad (18)$$

**Discussion.** Based on the above dependencies, in order to determine hydraulic losses in the above structural elements and previously obtained recommendations [17, 18] on the choice of geometric and kinematic parameters of coaxially installed impellers, calculations were made of hydraulic losses for the most effective design and operating parameters of coaxially installed impellers, in terms of hydraulic losses in the elements listed below.

**Outer impeller:**

- graphical dependences of losses on deceleration (Fig. 10, a), or acceleration of the fluid flow (Fig. 10, b) with a change in the relative velocity at the entrance to the outer stage of the impeller show a decrease in losses during deceleration and an increase in losses during acceleration of the flow;

- graphical dependences of losses on the transition of the fluid flow from the inner stage of the impeller to the outer (Figs. 11, a, b) show a decrease in losses with an increase in the relative flow velocity of the outer stage.

**Discharge device.** Hydraulic losses in the diverting device tend to increase with an increase in the absolute flow rate; they are shown in Fig. 12.

Based on the above graphical dependencies and previously obtained recommendations [10] on the choice of geometric and kinematic parameters of coaxially installed impellers, it was found that the coaxial arrangement of impellers in centrifugal pumps can reduce hydraulic losses by 23 %, and also contribute to an increase in pressure-flow characteristics, with unchanged overall dimensions of the unit.

**Conclusions.** On the basis of a review of scientific and patent literature, the necessity and possibility of improving

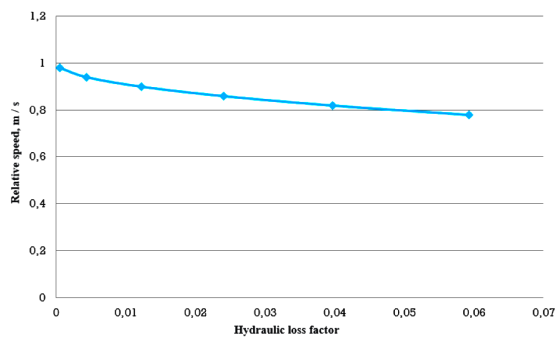

a

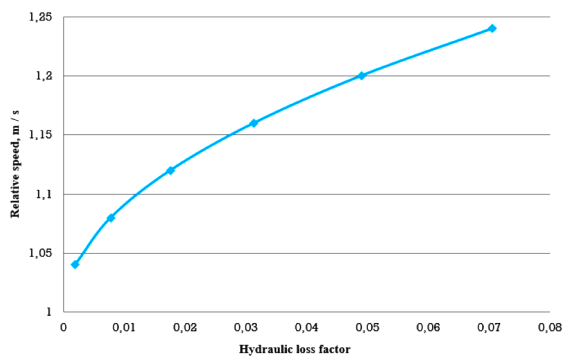

b

Fig. 10. Graphical dependences of energy losses in the impeller, depending on the relative flow velocity of the outer stage:

a – deceleration of the flow; b – acceleration of the flow

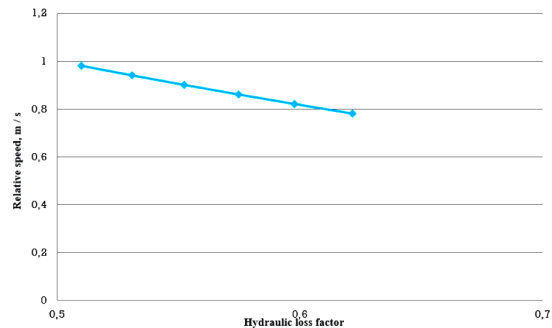

a

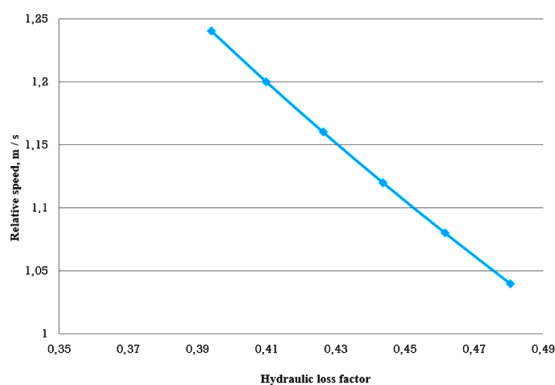

b

Fig. 11. Graphical dependences of losses on the transition of fluid from stage to stage, depending on the relative flow velocity of the external stage:

a – deceleration of the flow; b – flow acceleration

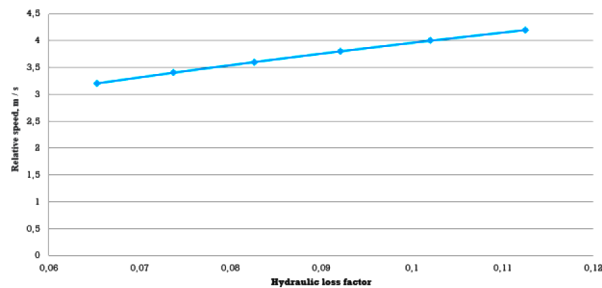

Fig. 12. Graphical dependences of energy losses in the diverting device, depending on the relative flow velocity of the external stage

the design of a centrifugal pump, providing a decrease in hydraulic losses in pump elements by up to 23 %, has been identified.

The structural scheme of the improved centrifugal pump provides for the presence of coaxially located impellers, which ensures the transfer of hydraulic energy from stage to stage, without the use of transfer channels, which ensures a decrease in hydraulic losses, an increase in the efficiency and energy efficiency of the pump.

According to the results of experimental studies, it was found that the increase in the pressure-flow characteristic of the developed structural and technological scheme was up to 75 % in pressure, and up to 60 % in flow with unchanged overall dimensions of the installation.

Computational and theoretical studies were carried out to determine the hydraulic losses in the presented structural elements and the choice of geometric and kinematic parameters of coaxially installed impellers of a centrifugal pump, which made it possible to identify patterns of change in energy losses in the impeller depending on the relative speed of the fluid flow in the outer stage and during the transition flow from the inner stage to the outer stage.

It has been proven that the expansion of the range of energy-efficient operation up to 56 % in vane blowers with coaxial impellers is achieved due to the rational selection of geometric parameters and operating modes of the impellers.

## References.

1. Grigoriev, S. V., Savin, L. A., & Shakhbanov, R. M. (2015). Substantiation of the possibilities of increasing the energy characteristics of centrifugal pumps. *Bulletin of TULSU*, (7, part 2), 122-127.
2. Commission Regulation (EC) No. 641/2009 of 22 July 2009. Retrieved from <https://eur-lex.europa.eu/legal-content/EN/TXT/PDF/?uri=CELEX:32009R0641>.
3. Taran, I. A., & Klimenko, I. Yu. (2014). Transfer ratio of double-split transmissions in case of planetary gear input. *Naukovyi Visnyk Natsionalnoho Hirnychoho Universytetu*, (6), 60-66.
4. Samorodov, V., Bondarenko, A., Taran, I., & Klymenko, I. (2020). Power flows in a hydrostatic-mechanical transmission of a mining locomotive during the braking process. *Transport Problems*, 15(3), 17-28. <https://doi.org/10.21307/tp-2020-030>.
5. Kandi, A., Moghimi, M., Tahani, M., & Houreh, S. D. (2020). Optimization of pump selection for running as turbine and performance analysis within the regulation schemes. *Energy*, 217, 119402. <https://doi.org/10.1016/j.energy.2020.119402>.
6. Urmila, B. (2011). Optimum space vector pwm algorithm for three-level inverter. *ARNP Journal of Engineering and Applied Sciences*, 6(9), 24-36.
7. Xiao-Qi Jia, Bao-Ling Cui, Zu-Chao Zhu, & Yu-Liang Zhang (2019). Experimental investigation of pressure fluctuations on inner wall of a centrifugal pump. *International Journal of Turbo & Jet-Engines*, 36(4), 401-410. <https://doi.org/10.1515/tjj-2016-0078>.
8. Yang, S.-S., Kong, F.-Y., Jiang, W.-M., & Qu, X.-Y. (2012). Effects of impeller trimming influencing pump as turbine. *Computers & Fluids*, 67, 72-78. <https://doi.org/10.1016/j.compfluid.2012.07.009>.
9. Ukhin, B. V. (2007). Effect of variation in the diameter of a centrifugal dredge impeller on its characteristics. *Power Technology and Engineering*, 41(1), 8-13.



10. Zhao, X., Luo, Y., Wang, Z., Xiao, Y., & Avellan, F. (2019). Unsteady flow numerical simulations on internal energy dissipation for a low-head centrifugal pump at part-load operating conditions. *Energies*, 12(10), 1-20. <https://doi.org/10.3390/en12102013>.
11. Zhao, X., Wang, Z., Xiao, Y., & Luo, Y. (2019). Thermodynamic analysis of energy dissipation and unsteady flow characteristic in a centrifugal dredge pump under over-load conditions. *Proceedings of the Institution of Mechanical Engineers, Part C: Journal of Mechanical Engineering Science*, 233(13), 095440621882435, 4742-4753. <https://doi.org/10.1177/0954406218824350>.
12. Forero, J. D., Taborda, L. L., & Silvera, A. B. (2019). Characterization of the performance of centrifugal pumps powered by a diesel engine in dredging applications. *International Review of Mechanical Engineering*, 13(1), 11-20.
13. Peng, G., Wang, Z., & Fu, S. (2015). Wear characteristics of flow parts of centrifugal dredge pump. *Journal of Drainage and Irrigation Machinery Engineering*, 33(12), 1013-1018. <https://doi.org/10.3969/j.issn.1674-8530.15.0161>.
14. Peng, G. J., Luo, Y. Y., & Wang, Z. W. (2015). Research on wear properties of centrifugal dredge pump based on liquid-solid two-phase fluid simulations. *IOP Conference Series Materials Science and Engineering*, 72(4), 042048, 1-6. <https://doi.org/10.1088/1757-899X/72/4/042048>.
15. Bugdayci, H. H., Munts, E., & Grinwis, H. (2013). Latest developments in dredge pump technology: how recent pump designs can improve the productivity of a dredge. *Proceedings WODCON XX – Congress and Exhibition: The Art of Dredging*. Retrieved from [https://www.cedaconferences.org/documents/dredgingconference/htmlpage/16/wodcon\\_xx\\_low\\_res.pdf](https://www.cedaconferences.org/documents/dredgingconference/htmlpage/16/wodcon_xx_low_res.pdf).
16. Xu, Z., Jin, Z., Liu, B., & Bengt, S. (2019). Experimental investigation on solid suspension performance of coaxial mixer in viscous and high solid loading systems. *Chemical Engineering Science*, 208, 115144. <https://doi.org/10.1016/j.ces.2019.08.002>.
17. Holmberg, H., Acuna, J., Naess, E., & Sonju, O. K. (2016). Thermal evaluation of coaxial deep borehole heat exchangers. *Journal Renewable Energy*, 97, 65-76. <https://doi.org/10.1016/j.renene.2016.05.048>.
18. Dijkshoorn, L., Speer, S., & Pechnig, R. (2013). Measurements and design calculations for a deep coaxial borehole heat exchanger in Aachen, Germany. *International Journal of Geophysics*, 2013, 916541, 1-14. <https://doi.org/10.1155/2013/916541>.
19. Kong, Z., & Liu, P. (2020). Simulation analysis of mechanical performance of the broadband coaxial step attenuator. *Journal of Physics: Conference Series*. 3<sup>rd</sup> International Conference on Applied Mathematics, Modeling and Simulation, 1670, 012003, 1-7. <https://doi.org/10.1088/1742-6596/1670/1/012003>.
20. Zhai, L. M., Cao, L., Cao, J. W., Lei, H. M., Ahn, S. H., Chen, F. N., ..., & Wang, Z. W. (2021). Numerical analysis of rotor dynamics of dredge pump shafting. 2<sup>nd</sup> IAHR-Asia Symposium on Hydraulic Machinery and Systems, IAHR-Asia 2019, 627, 012015, 1-8.
21. Cardenas-Gutierrez, J. A., Valencia, G. Ochoa, & Duarte Fore-ro, J. (2020). Parametric analysis CFD of the hydraulic performance of a centrifugal pump with applications to the dredging industry. *Journal of Engineering Science and Technology Review*, 13(3), 8-14. <https://doi.org/10.25103/jestr.133.02>.
22. Shuang, J., Fusheng, N., & Ting, L. (2019). Research on the multi-loop control system for swing process of cutter suction dredger. SACRE2019: Proceedings of the 2019 4<sup>th</sup> International Conference on Automation, Control and Robotics Engineering, 43, 1-6. <https://doi.org/10.1145/3351917.3351968>.
23. Working principle of multistage centrifugal pump (2019). Retrieved from <https://c-triada.ru/masteru/printsip-raboty-mnogostupenchatogo-tsentrobezhnogo-nasosa.html>.
24. Pumps: history and principle of operation of different types of pumping units (2020). Retrieved from <https://zen.yandex.ru/media/>

[id/5ed4b30b234d116acb057a7c/nasosy-istoriia-i-princip-raboty-raznyh-tipov-nasosnyh-agregatov-5f4698f2ca90bb1dc75b45ad](https://doi.org/10.3390/en12102013).

## Шляхи зниження гідравлічних втрат у багатоступінчастому відцентровому насосному обладнанні гірничої та нафтодобувної промисловості

Г. Аканова<sup>1</sup>, О. Сладковські<sup>2</sup>, С. Підболотов<sup>3</sup>,  
А. Кольга<sup>4</sup>, І. Столповських<sup>1</sup>

1 – Satbaev University, м. Алмати, Республіка Казахстан, e-mail: [kairatguldana8@gmail.com](mailto:kairatguldana8@gmail.com)

2 – Сілезький технічний університет, м. Катовіце, Республіка Польща

3 – Магнітогорський державний технічний університет імені Г. І. Носова, м. Магнітогорськ, Російська Федерація

4 – Уральський державний аграрний університет, м. Єкатеринбург, Російська Федерація

**Мета.** Вивчення гідравлічних втрат у насосних агрегатах під час перекачування та транспортування рідин, розробка конструкторських і технологічних рішень для підвищення енергоефективності відцентрових насосів у гірничій і нафтодобувній промисловості.

**Методика.** У теоретичному та експериментальному аналізі гідравлічних втрат при транспортуванні рідин були використані методи теорії гідравліки та експериментального аналізу.

**Результати.** У результаті виконаних досліджень була розроблена нова конструктивна схема багатоступінчастого відцентрового насоса, передбачуване співвісне (коаксіальне) розташування робочих коліс, що дозволяє зменшити гідравлічні втрати в елементах насоса, а також підвищити енергоефективність роботи насосних агрегатів.

**Наукова новизна.** На основі аналізу існуючих конструкцій багатоступінчастих нагнітачів осьового й відцентрового типів розглянуто розподіл гідравлічних втрат в елементах відцентрового нагнітача зі співвісним (коаксіальним) розташуванням робочих коліс. Представлені експериментальні залежності зі встановлення напірно-видаткових і потужних характеристик. На основі врахування гідравлічних втрат проведена оцінка енергоефективності конструкції насосної установки зі співвісним розташуванням робочих коліс.

**Практична значимість.** Нова конструктивна схема відцентрового насоса зі співвісним розташуванням робочих коліс дозволяє зменшити гідравлічні втрати більш ніж на 23 % у порівнянні з традиційними конструкціями відцентрових насосів. Результати роботи можуть бути використані проектними, науково-дослідними та промисловими організаціями, зайнятими проектуванням і експлуатацією насосного обладнання.

**Ключові слова:** системи гідротранспорту, відцентровий насос, гідравлічні втрати, співвісне розташування робочих коліс

The manuscript was submitted 04.04.21.