

O. V. Fomin<sup>1</sup>,  
 orcid.org/0000-0003-2387-9946,  
 A. O. Lovska<sup>2</sup>,  
 orcid.org/0000-0002-8604-1764

1 – The State University of Infrastructure and Technologies,  
 Kyiv, Ukraine, e-mail: [fomin1985@ukr.net](mailto:fomin1985@ukr.net)  
 2 – The Ukrainian State University of Railway Transport,  
 Kharkiv, Ukraine

## DETERMINATION OF VERTICAL DYNAMICS FOR A STANDARD UKRAINIAN BOXCAR WITH Y25 BOGIES

**Purpose.** To determine the basic dynamic characteristics of a standard Ukrainian boxcar with the Y25 bogie by means of the mathematic modelling of dynamic loads in the vertical plane and to compare them with the dynamic characteristics obtained for a boxcar with the 18–100 bogie. It can be used for substantiation of application of the Y25 bogie as more promising, which can improve the operational efficiency of rail transportation and foster integration of the Ukrainian transport system into the European transportation complex.

**Methodology.** The authors used the mathematical modelling of a boxcar with the Y25 bogie. The research was made in the vertical plane. It was taken into account that an empty car passed over a joint irregularity. The research was made for an 11–217 boxcar as a predominant type to be used. The authors studied the motion of a car on the 18–100 and Y25 bogies. The basic dynamic characteristics were determined for a boxcar with the nominal (design) dimensions of the carrying elements and a boxcar with the actual dimensions (after a long service life) on the basis of the field tests. The differential equations were solved by the Runge–Kutta method in MathCad software suite. The initial displacements and the speeds were taken equal to zero. The following dynamic characteristics of a boxcar were obtained: acceleration of the body in the center of mass, acceleration of the body in the areas of support on the bogies, forces in the spring suspension of the bogie, and dynamic coefficients of the bogies.

**Findings.** The theoretical research showed that the basic dynamic characteristics of a boxcar with the nominal dimensions were improved by 38–51 % in comparison to a similar one with the 18–100 bogie, and for a boxcar with the actual dimensions the dynamic characteristics were improved by 43–50 %.

**Originality.** The authors substantiated the application of the Y25 bogie for a standard Ukrainian boxcar with the nominal and actual dimensions of the carrying elements by means of the mathematical modelling of the dynamic loads in the vertical plane.

**Practical value.** Due to lower dynamic loads on the carrying structures of freight cars with the Y25 bogie, it is possible to improve the dynamic characteristics of the structures under the operational modes, to increase the fatigue strength and the operational resource, to decrease the total repair and maintenance costs, to ensure better security and reliability of freight transportation through lower loads on both carrying structures and lashing devices, to increase the speed of freight delivery thanks to better dynamic characteristics of cars, to improve the traffic security, and so on.

**Keywords:** *transport mechanics, boxcar, dynamic loading, bogie, load modelling*

**Introduction.** In accordance with the Ukraine-European Union Association Agreement (Chapter 7 “Transport”, Article 367) the parties to the agreement shall “... promote efficient, safe and secure transport operations ...” and “... contribute to the development of sustainable transport systems.” It emphasizes the need for scientific research and development aimed at seeking solutions to the tasks formulated.

And one of possible variants to solve these tasks is implementation of freight cars with bogies of improved technical characteristics. It will enhance not only the operational characteristics of a car, but the strength characteristics due to decreased dynamic loads. It can be achieved by application of European Y25 bogies as an alternative for 18–100 bogies.

It should also be noted that this solution is especially feasible for the transport means with the depleted working resource. It will improve the efficiency of transportation for the existing rail vehicles.

**Literature review.** The peculiarities of determination of the dynamic loads on the carrying structure of a car are studied in [1]. The authors considered application of different types of bogies for rail cars. However, they do not study an impact of the technical characteristics of these bogies on the fatigue strength of the carrying elements of rail cars and their operational resource.

The dynamics and optimization of a modern double-axle bogie are studied in [2]. A special feature of this bogie is its structure of two pieces connected by the diagonal rods.

But these studies do not present any research into the dynamics of cars with the actual dimensions of carrying elements on the bogies under considerations.

Study [3] is devoted to how the stiffening and damping components of the basic and additional suspensions affect the dynamic characteristics of a high speed train. The analysis was

made for a rail car with the symmetrical and asymmetrical suspension configurations.

However, the authors did not study how the dynamic loads on the carrying structure of a car can be decreased.

The structural features of new generation bogies are analyzed in [4]. The authors described the main advantages and disadvantages of the existing bogies. They especially emphasized the LEILA and SUSTRAIL bogies. But the Y25 bogie was only mentioned in the study.

The dynamic characteristics of a bogie moving on the curve were studied by means of the bifurcation analysis in [5]. The Hopf bifurcation was analyzed for a two-axle bogie and a doubled wheelset under the non-linear damping forces. It should be noted that the authors did not consider how the bogie dynamics impacted the loading on the carrying structure of a car.

Study [6] presents some measures aimed at a decrease in the dynamic loads on the carrying structure of a car by applying spring elements, and study [7] – by applying elements with viscous links. However, implementation of bogies with the optimal technical characteristics to decrease the dynamic loads on the carrying structure of a car is not described.

**Unsolved aspects of problem.** The analysis of the literature has proven that it is of primary importance to explore a possibility of applying the Y25 bogie for a boxcar with flat center plates. This will improve the dynamic characteristics of the carrying structures of freight cars under operational modes, increase the fatigue strength, operation resource, and decrease the repair costs, improve security of freight transportation due to decreased loads on the carrying structure of cars and lashing devices, increase the freight delivery, improve traffic safety, and so on.

**Purpose.** The objective of the article is determination of the basic dynamic characteristics of a typical Ukrainian boxcar with European Y25 bogies by means of the mathematic mod-

elling of the dynamic loads in the vertical plane and their comparison with the dynamic characteristics obtained for the 18–100 bogie. This will ground the application of the Y25 bogies as more promising; it will improve the efficiency of rail transportation and foster integration of Ukraine’s transport system into the European transportation complex.

**Methods.** The substantiation of the efficiency of the Y25 bogie for a boxcar is primarily based on determination of the dynamic loads. The following tasks were set in the research:

1. The mathematical modelling of the dynamic loads on the carrying structure of a boxcar with the design dimensions on the 18–100 and Y25 bogies.

2. The mathematical modelling of the dynamic loads on the carrying structure of a boxcar with the actual dimensions on the 18–100 and Y25 bogies.

3. The comparative analysis of the modelled dynamic loads for a boxcar with different bogie types.

**Results.** The dynamic characteristics of the basic Ukrainian freight cars can be improved on the basis of research into a possibility to use the Y25 bogie (Fig. 1).

The bogie has a stamp-welded frame. The primary one-stage spring suspension is equipped with a friction wedge oscillation distinguisher. The bogie frame is rested on the axle-box lugs through the cylindrical springs. The axle-box body is placed in the axlebox guide and has vertical travel restrainers. The bogie is equipped with constant contact bearers.

The basic technical characteristics of the Y25 bogie are given in Table 1 [8].

Unlike European Y25 bogies, the bogies manufactured in CIS countries have moulded side frames, bolster beam and brake shoes with unilateral pressure [9].

The basic dynamic characteristics of the carrying structures of a freight car with the Y25 bogie were determined through the mathematical modelling on the basis of the mathematical model devised by Prof. Yu. V. Diomin and Assoc. Prof. G. Yu. Cherniak. The research included the oscillations of the carrying structures of a freight car in the vertical plane, i. e. the bouncing oscillations, being one of the most predominant oscillation types during operation [10]. The study was based on the motion of an empty car as a case of the maximum dynamic loading when a car passed over a joint irregularity [11]. The track was taken as a viscous elastic component. The track responded proportionally to both the deformation and the speed of this deformation. The design diagram is presented in Fig. 2.

The input parameters of the model were the technical characteristics of the carrying structure of a car with the design and actual dimensions, the spring suspension of the bogies, and the disturbing force (Table 2) [12]. The actual dimensions of the carrying structure of a boxcar were determined through the field tests.

An 11-217 boxcar manufactured by AO Altaivagon (Fig. 3) was used for the research as a predominant freight car type in Ukraine.

The inertia coefficients of the Y25 bogie were determined by means of a spatial model in the Pro/e software complex (Fig. 4).

The motion equation for the design model is as follows



Fig. 1. A Y25 bogie

Table 1

The basic technical characteristics of the Y25 bogie

Parameter	Dimension	Value
Mass	ton	4.9 ( $\pm 5\%$ )
Track	mm	1435
Bogie base	mm	1800
Wheel diameter, (max/min)	mm	920/840
Distance between the rail head and the center of the pivotal spherical center plate at a car weight of 20 tons	mm	790
Cross gaps in the axlebox guides	mm	$2 \times 10$
Maximum axle load	tons per axle	22.5
Speed of a freight car at an axle load of 22.5 tons per axle	km per hour	100
Speed of a freight car at an axle load of 20.0 tons per axle	km per hour	120
Specific flexibility of spring suspension at a load from the axle to the rail up to 6.63 tons	mm per ton	2.45
Specific flexibility of spring suspension at a load from the axle to the rail over 6.63 tons	mm per ton	0.93

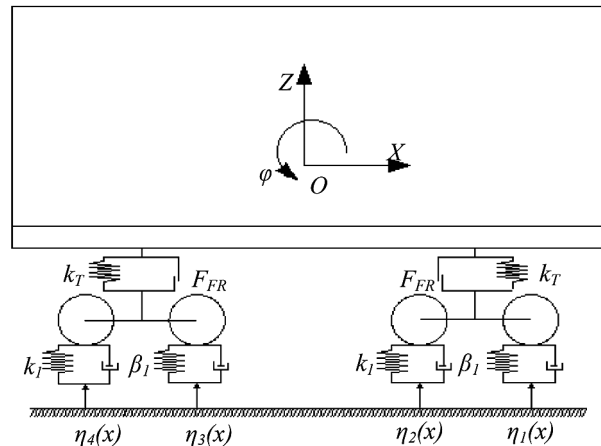

Fig. 2. The design diagram of a boxcar

Table 2

The input parameters of the mathematical model

Parameter	Value
The 18–100 bogie	
mass, t	4.3
inertia moment, $t \cdot m^2$	3.0
half-base, m	0.925
spring suspension rigidity, kN/m	8000.0
The Y25 bogie	
mass, t	4.85
inertia moment, $t \cdot m^2$	6.7
half-base, m	0.9
spring suspension rigidity, kN/m	4004.1
Track	
damping coefficient, $kN \cdot s/m$	200
rigidity, kN/m	100 000
irregularity amplitude, m	0.01
irregularity length, m	25



Fig. 3. An 11-217 boxcar

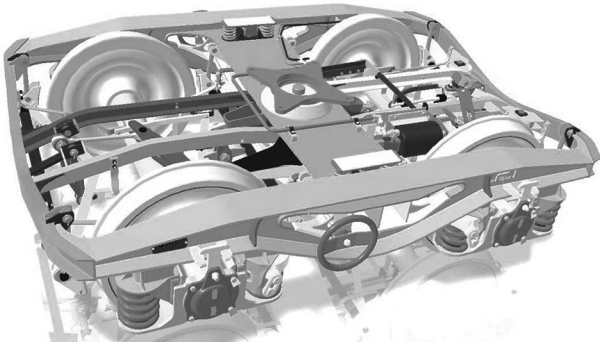

Fig. 4. The spatial model of a Y25 bogie

$$M_1 \cdot \frac{d^2}{dt^2} q_1 + C_{1,1} \cdot q_1 + C_{1,3} \cdot q_3 + C_{1,5} \cdot q_5 = F_z; \quad (1)$$

$$M_2 \cdot \frac{d^2}{dt^2} q_2 + C_{2,2} \cdot q_2 + C_{2,3} \cdot q_3 + C_{2,5} \cdot q_5 = F_\phi; \quad (2)$$

$$M_3 \cdot \frac{d^2}{dt^2} q_3 + C_{3,1} \cdot q_1 + C_{3,2} \cdot q_2 + C_{3,3} \cdot q_3 + B_{3,3} \cdot \frac{d}{dt} q_3 = F_z^{b1}; \quad (3)$$

$$M_4 \cdot \frac{d^2}{dt^2} q_4 + C_{4,4} \cdot q_4 + B_{4,4} \cdot \frac{d}{dt} q_4 = F_\phi^{b1}; \quad (4)$$

$$M_5 \cdot \frac{d^2}{dt^2} q_5 + C_{5,1} \cdot q_1 + C_{5,2} \cdot q_2 + C_{5,5} \cdot q_5 + B_{5,5} \cdot \frac{d}{dt} q_5 = F_z^{b2}; \quad (5)$$

$$M_6 \cdot \frac{d^2}{dt^2} q_6 + C_{6,6} \cdot q_6 + B_{6,6} \cdot \frac{d}{dt} q_6 = F_\phi^{b2}; \quad (6)$$

$$F_z = -F_{FR} \cdot \left( \text{sign} \left( \frac{d}{dt} \delta_1 \right) + \text{sign} \left( \frac{d}{dt} \delta_2 \right) \right);$$

$$F_\phi = F_{FR} \cdot l \cdot \left( \text{sign} \left( \frac{d}{dt} \delta_1 \right) + \text{sign} \left( \frac{d}{dt} \delta_2 \right) \right);$$

$$F_z^{b1} = F_{FR} \cdot \text{sign} \left( \frac{d}{dt} \delta_1 \right) + k_1 (\eta_1 + \eta_2) + \beta_1 \left( \frac{d}{dt} \eta_1 + \frac{d}{dt} \eta_2 \right);$$

$$F_\phi^{b1} = -k_1 (\eta_1 - \eta_2) - \beta_1 \cdot a \cdot \left( \frac{d}{dt} \eta_1 - \frac{d}{dt} \eta_2 \right);$$

$$F_z^{b2} = F_{FR} \cdot \text{sign} \left( \frac{d}{dt} \delta_2 \right) + k_1 (\eta_3 + \eta_4) + \beta_1 \left( \frac{d}{dt} \eta_3 + \frac{d}{dt} \eta_4 \right);$$

$$F_\phi^{b2} = -k_1 \cdot a \cdot (\eta_3 - \eta_4) - \beta_1 \cdot a \cdot \left( \frac{d}{dt} \eta_3 - \frac{d}{dt} \eta_4 \right),$$

where  $M_1, M_2$  are mass and inertia moment of the carrying structure of a car at bouncing and galloping oscillations, respectively;  $M_3, M_4$  are mass and inertia moment of the first bogie facing the engine at bouncing and galloping oscillations, respectively;  $M_5, M_6$  are mass and inertia moment of the second bogie facing the engine at bouncing and galloping oscillations, respectively;  $C_{ij}$  is elasticity characteristic of the oscillation system elements;  $B_i$  is scattering function;  $a$  is half-base of a bogie;  $q_i$  is generalized coordinates corresponding to the advancing movement relative to the vertical axle and the angular displacements around the vertical axle;  $k_i$  is spring suspension rigidity;  $\beta_i$  is damping coefficient;  $F_{FR}$  is absolute friction force in a spring group.

The masses and the inertia moments of the carrying structures of a boxcar with the design and actual dimensions were found through their spatial models built in the SolidWorks software [13]. With standard options from the software suite [14] it was found that the mass of the carrying structure of a boxcar with the nominal dimensions was 15.3 t, the inertial moment – 320.8 t · m<sup>2</sup>, and of a boxcar with the actual dimensions – 12.7 t and 265.6 t · m<sup>2</sup>, respectively (Fig. 5).

Differential equations (1–6) were solved in the MathCad software [15]. They were reduced to the normal Cochy form [16]. After that they were integrated by the Runge-Kutta method [17]. The initial displacements and the speeds were taken equal to zero [18]. On the basis of the calculations, the authors found the basic dynamic characteristics of the freight cars with the nominal and actual dimensions on the 18–100 and Y25 bogies. The accelerations on the carrying structure of a boxcar in the center of mass are given in Fig. 6. Mathematical model (1–6) was also used for determination of other dynamic characteristics of a boxcar with the nominal dimensions (Table 3). The calculation was made for a car moving at a speed of 80 km per hour. The changes in accelerations on the structure of a boxcar with the nominal (design) dimensions in the center of mass are given in Fig. 6.

The results of the comparative study on the dynamic characteristics of a boxcar are given in Fig. 7: I – accelerations on the bogie in the center of mass, m/s<sup>2</sup>, II – accelerations of a body in the areas of support on the bogies, III – force in the spring suspension of a bogie, kN; IV – dynamic coefficient of a bogie.

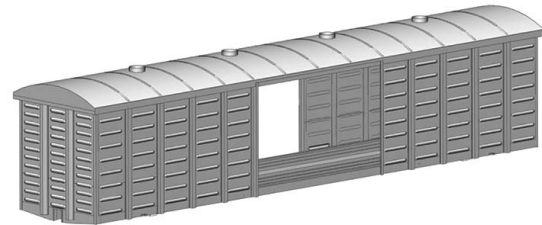

a

Массовые характеристики: КВ 2			
Конфигурация: Default			
Система координат: -- по умолчанию --			
Плотность = 7800.00 килограммов на кубический метр			
Масса = 12661.37 килограммов			
Объем = 1.62 кубические метры			
Площадь поверхности = 417.58 квадратных метры			
Центр тяжести: ( метры )			
X = 0.19			
Y = 0.94			
Z = 0.00			
Основные оси инерции и основные моменты инерции: ( килограммов * квадратные метры )			
центр тяжести			
Ix = (0.00, 0.00, 1.00)	Px = 23457.88		
Iy = (0.00, -1.00, 0.00)	Py = 257417.69		
Iz = (1.00, 0.00, 0.00)	Pz = 265607.64		
Моменты инерции: ( килограммов * квадратные метры )			
Вычисляется с помощью системы координат вывода.			
Lxx = 297807.64	Lxy = -0.48	Lxz = 7.39	
Lyx = -0.48	Lyy = 287417.69	Lyz = -2.60	
Lxz = 7.39	Lzy = -2.60	Lzz = 31457.88	
Моменты инерции: ( килограммов * квадратные метры )			
Вычисляется с помощью системы координат вывода.			
Ixx = 308886.07	Iyy = 2254.96	Ixz = 6.48	
Iyx = 2254.96	Iyy = 287876.88	Iyz = -7.05	
Ixz = 6.48	Izy = -7.05	Izz = 42995.50	
Справка			
Печать...			
Копировать в буфер			

b

Fig. 5. The model of the carrying structure of a boxcar with the actual dimensions:

a – spatial model; b – data on the model

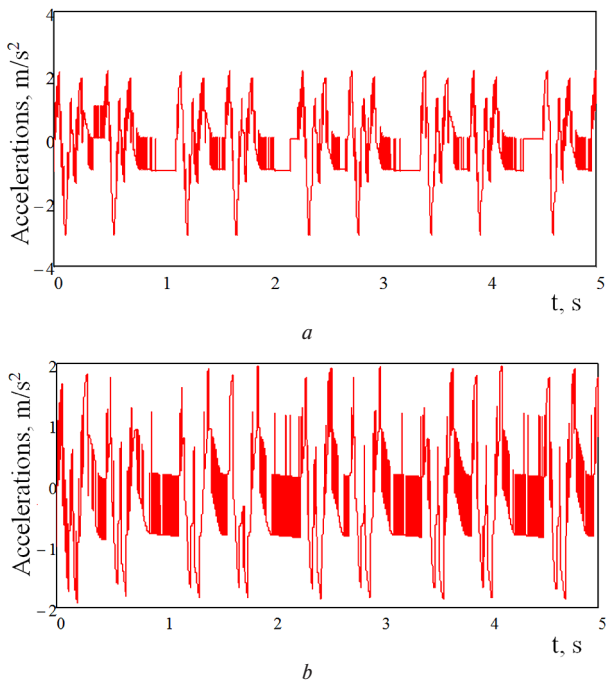

Fig. 6. The accelerations on the carrying structure of a boxcar with the nominal dimensions in the center of mass:  
a – 18–100 bogie; b – Y25 bogie

Table 3

The dynamic characteristics of a boxcar with the nominal dimensions

Factor	Bogie type	
	18–100	Y25
Bogie acceleration, $m/s^2$	2.99	1.84
Acceleration of a body in the areas of support on the bogie, $m/s^2$	5.44	2.68
Force in the spring suspension of a bogie, kN	38.5	20.4
Dynamic coefficient of a bogie	0.51	0.28

The dynamic characteristics did not exceed the allowable values [19]. Thus, application of the Y25 bogie for a boxcar can decrease (improve) the accelerations on the carrying structure of a boxcar by about 39 % if compared to the 18–100 bogie. The other dynamic characteristics were also improved (Fig. 7). And the motion of the car was estimated as excellent [20].

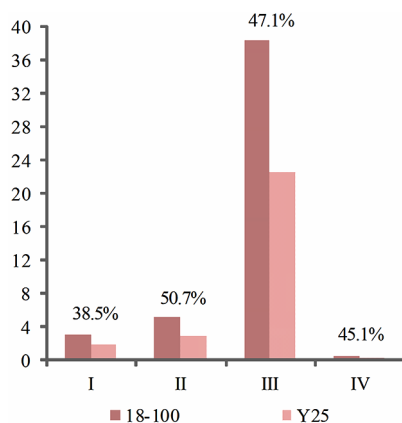

Fig. 7. The comparative analysis of dynamic characteristics of a boxcar with the nominal dimensions

The changes in accelerations on the carrying structure of a boxcar with the actual dimensions (after a long service life) in the center of mass are given in Fig. 8.

Mathematical model (1–6) was used for determination of other dynamic parameters of a boxcar with the actual dimensions (Table 4).

The results obtained demonstrated that the dynamic parameters were within the allowable values [19]. And the motion of the car was estimated as excellent [20].

The comparison analysis of the characteristics obtained for a boxcar is presented in Fig. 9.

Thus, application of the Y25 bogie for a boxcar can decrease (improve) the acceleration on the carrying structure by about 43 % in comparison to the 18–100 bogie (Fig. 9).

### Conclusions.

1. The study deals with the mathematical modelling of dynamic loads on the carrying structure of a Ukrainian boxcar with the nominal dimensions on the 18–100 and Y25 bogies. The calculation took into account the fact that the car passed over a joint irregularity with a speed of 80 km/h. It was found that application of the Y25 bogie for a boxcar with the nominal dimensions can decrease the acceleration on the carrying structure by about 39 % in comparison to the 18–100 bogie.

2. The authors researched into the dynamic loading on the carrying structure of a boxcar with the actual dimensions with

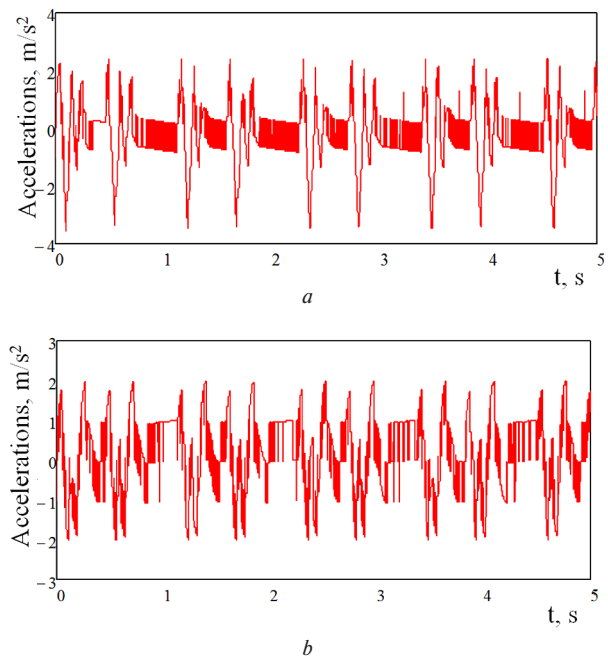

Fig. 8. The accelerations on the carrying structure of a boxcar with the actual dimensions in the center of mass:  
a – 18–100 bogie; b – Y25 bogie

Table 4

The dynamic characteristics of a boxcar with the actual dimensions

Factor	Bogie type	
	18–100	Y25
Body acceleration, $m/s^2$	3.5	2.0
Accelerations of a body in the areas of support on the bogie, $m/s^2$	6.6	3.4
Force in the spring suspension of a bogie, kN	38.9	19.5
Dynamic coefficient of a bogie	0.6	0.3

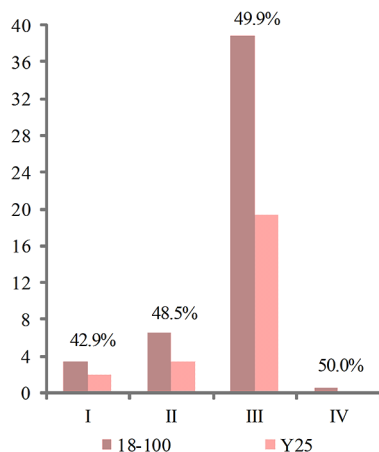

Fig. 9. The comparative analysis of the dynamic characteristics of a boxcar with the actual dimensions

the 18–100 and Y25 bogies. Thus, this solution may decrease the acceleration on the carrying structure of a car by about 39 % in comparison to the 18–100 bogie.

3. The research also deals with the comparative study on the modelled dynamic loads to a boxcar for different bogie types. It was found that the basic dynamic characteristics of a boxcar (accelerations of a bogie in the center of mass, accelerations of a body in the areas of support on the bogies, forces in the spring suspension of a bogie, dynamic coefficients of bogies) with the nominal dimensions decreased by 38–51 % in comparison to those with the 18–100 bogie. The basic dynamic characteristics of a boxcar with the actual dimensions decreased by 43–50 % in comparison to ones with standard 18–100 bogies.

A decrease in the dynamic loads on the carrying structures of a freight car on the Y25 bogie can improve the dynamic characteristics of the structure under operational modes, increase the fatigue strength, operation resource, and decrease the repair and maintenance costs, improve the security of freight transportation and lashing devices, improve the freight delivery and traffic safety, and so on.

**Acknowledgements.** This publication is part of the project “Development of conceptual measures for renovation of efficient operation of used freight cars” (Registration Number is 2020.02/0122). The project is funded by the state budgetary institution National Research Foundation of Ukraine.

#### References.

- Myamlin, S., Povilas, L.L., Dailydka, S., Vaičiūnas, G., Bogdevičius, M., & Bureika, G. (2015). Determination of the dynamic characteristics of freight wagons with various bogie. *Transport*, 30(1), 88–92. <https://doi.org/10.3846/16484142.2015.1020565>.
- Savoskin, A. N., Akishin, A. A., & Yurchenko, D. (2018). Dynamics and optimization of a new double-axle flexible bogie for high-speed trains. *Proceedings of the Institution of Mechanical Engineers, Part F: Journal of Rail and Rapid Transit*, 232(5), 1549–1558. <https://doi.org/10.1177/0954409717737879>.
- Seyed Milad Mousavi Bideleh, & Berbyuk, V. (2016). Global sensitivity analysis of bogie dynamics with respect to suspension components. *Multibody System Dynamics*, 37, 145–174.
- Iwnicki, S. D., Stichel, S., Orlova, A., & Hecht, M. (2015). Dynamics of railway freight vehicles. *Vehicle System Dynamics*, 53, 995–1033.
- Uyulan, C., Gokasan, M., & Bogosyan, S. (2017). Dynamic Investigation of the Hunting Motion of a Railway Bogie in a Curved Track via Bifurcation Analysis. *Mathematical Problems in Engineering*, 2017. <https://doi.org/10.1155/2017/8276245>.
- Fomin, O., & Lovska, A. (2020). Establishing patterns in determining the dynamics and strength of a covered freight car, which exhausted its resource. *Eastern-European Journal of Enterprise Technologies*, 6(7(108)), 21–29. <https://doi.org/10.15587/1729-4061.2020.217162>.
- Lovska Alyona, & Fomin Oleksij (2020). A new fastener to ensure the reliability of a passenger coach car body on a railway ferry.

*Acta Polytechnica*, 60(6), 478–485. <https://doi.org/10.14311/AP.2020.60.0478>.

- Tatravagonka Poprad (n.d.). Retrieved from <http://tatravagonka.sk/bogie/y25lssif-d/?lang=ru>.
- Ignatenkov, G. I., Slesarev, S. I., Romen, Yu. S., Dolmatov, A. A., Belousov, V. N., Tikhonenkov, A. P., & Ojya, V. I. (2006). *Railway vehicle bogie*. (Russian Federation Patent No. 2099220).
- Fomin, O., Lovska, A., Masliyev, V., Tsybaliuk, A., & Burlutski, O. (2019). Determining strength indicators for the bearing structure of a covered wagon’s body made from round pipes when transported by a railroad ferry. *Eastern-European Journal of Enterprise Technologies*, 1(7(97)), 33–40. <https://doi.org/10.15587/1729-4061.2019.154282>.
- Fomin, O., Lovska, A., Pištěk, V., & Kučera, P. (2019). Dynamic load effect on the transportation safety of tank containers as part of combined trains on railway ferries. *VIBROENGINEERING PROCEDIA*, 29, 124–129. <https://doi.org/10.21595/vp.2019.21138>.
- Plakhtii, O., Nerubatskyi, V., Scherbak, Ya., Mashura, A., & Khomenko, I. (2020). Energy efficiency criterion of power active filter in a three-phase network. *2020 IEEE KhPI Week on Advanced Technology (KhPIWeek)*, 165–170. <https://doi.org/10.1109/KhPI-Week51551.2020.9250073>.
- Plakhtii, O., Nerubatskyi, V., Mashura, A., Hordiienko, D., & Khoruzhevskiy, H. (2020). Improving energy indicators of the charging station for electric vehicles based on a three-level active rectifier. *Eastern-European Journal of Enterprise Technologies*, 3(8(105)), 46–55. <https://doi.org/10.15587/1729-4061.2020.204068>.
- Plakhtii, O., Nerubatskyi, V., Khomenko, I., Tsybulnyk, V., & Syniavskiy, A. (2020). Comprehensive study of cascade multilevel inverters with three level cells. *2020 IEEE 7th International Conference on Energy Smart Systems (ESS)*, 277–282. <https://doi.org/10.1109/ESS50319.2020.9160258>.
- Vatulia, G., Komagorova, S., & Pavliuchenkov, M. (2018). Optimization of the truss beam. Verification of the calculation results. *MATEC Web of Conferences*, 230, 02037. <https://doi.org/10.1051/mateconf/201823002037>.
- Vatulia, G. L., Lobiak, O. V., Deryzemlia, S. V., Verevicheva, M. A., & Orel, Ye. F. (2019). Rationalization of cross-sections of the composite reinforced concrete span structure of bridges with a monolithic reinforced concrete roadway slab. *IOP Conference Series: Materials Science and Engineering*, 664, 012014. <https://doi.org/10.1088/1757-899X/664/1/012014>.
- Kondratiev, A. V., Gaidachuk, V. E., & Kharchenko, M. E. (2019). Relationships between the ultimate strengths of polymer composites in static bending, compression, and tension. *Mechanics of Composite Materials*, 52(2), 259–266.
- Dižo, J., Steišūnas, S., & Blatnický, M. (2016). Simulation analysis of the effects of a rail vehicle running with wheel flat. *Manufacturing Technology*, 16(5), 889–896.
- Freight wagons. *Requirements for strength and dynamic properties. GOST 33211-2014* (2016). Moscow: Standartinform. Retrieved from <http://docs.cntd.ru/document/1200121493>.
- Freight wagons. *General requirements for calculations and design of new and modernized wagons of 1520 mm gauge (non-self-propelled). DSTU 7598:2014* (2015). Kyiv. Retrieved from [http://online.budstandart.com.ua/catalog/doc-page.html?id\\_doc=73763](http://online.budstandart.com.ua/catalog/doc-page.html?id_doc=73763).

## Визначення вертикальної динаміки типової конструкції критого вагона вітчизняного парку при використанні європейських візків Y25

О. В. Фомін<sup>1</sup>, А. О. Ловська<sup>2</sup>

<sup>1</sup> – Державний університет інфраструктури та технологій, м. Київ, Україна e-mail: [fomin1985@ukr.net](mailto:fomin1985@ukr.net)

<sup>2</sup> – Український державний університет залізничного транспорту, м. Харків, Україна

**Мета.** Визначення основних показників динаміки типової конструкції критого вагона вітчизняного парку на європейських візках типу Y25 шляхом математичного моделювання динамічної навантаженості у вертикальній площині й порівняння їх з показниками динаміки, отриманими для візків 18–100. Це дозво-

лить обґрунтувати доцільність упровадження даних візків, як більш перспективних і сприятиме підвищенню ефективності експлуатації залізничного транспорту та євроінтеграції вітчизняного транспортного комплексу.

**Методика.** Для обґрунтування використання візків типу Y25 під критим вагоном проведено математичне моделювання. Дослідження проведені у вертикальній площині. Ураховано, що вагон рухається стиковою нерівністю. В якості прототипу обрано критий вагон моделі 11–217, як найбільш розповсюджений. При цьому розглянуто рух вагона на візках типу 18–100 та Y25. Визначення основних показників динаміки здійснено для критого вагона з номінальними (креслярськими) розмірами несучих елементів, а також фактичними (після тривалої експлуатації), які визначені на підставі натурних досліджень. Розв'язок диференціальних рівнянь здійснено у програмному комплексі MathCad за методом Рунге-Кутта. Початкові переміщення та швидкості покладені рівними нулю. При цьому отримані такі основні показники динаміки вагона: прискорення кузова в центрі мас, прискорення кузова в зонах спірання на візки, сили в ресорному підвішуванні візків, коефіцієнти динаміки візків.

**Результати.** У ході проведених теоретичних досліджень встановлено, що основні показники динаміки критих вагонів з номінальними розмірами зменшуються на 38–51 % у порівнянні з використанням під ними ти-

пових візків 18–100, а критих вагонів з фактичними розмірами – на 43–50 %.

**Наукова новизна.** Проведено обґрунтування доцільності використання візків типу Y25 під типовими конструкціями критих вагонів вітчизняного парку з номінальними й фактичними розмірами несучих елементів шляхом математичного моделювання їх динамічної навантаженості у вертикальній площині.

**Практична значимість.** За рахунок зменшення динамічних навантажень, що діють на несучі конструкції вантажних вагонів на візках Y25, стає можливим покращити динамічні показники їх конструкцій за експлуатаційних режимів, підвищити втомну міцність, ресурс експлуатації та, відповідно, зменшити витрати на їх ремонт і експлуатацію в цілому, покращити збереженість вантажів і надійності їх перевезень за рахунок зменшення навантажень, що діють на несучі конструкції вагонів, а, відповідно, й засоби закріплення вантажів у них, підвищити швидкість доставки вантажів за рахунок покращення показників динаміки вагонів, покращити безпеку руху тощо.

**Ключові слова:** *транспортна механіка, критий вагон, динамічна навантаженість, візок, моделювання навантаженості*

*Recommended for publication by S. Yu. Sapronova, Doctor of Technical Sciences. The manuscript was submitted 08.01.21.*